

TP4-LP Loop Powered Process Monitor

Operation and Instruction Manual

Models TP4-LP-4C and TP4-LP-5C

AMALGAMATED INSTRUMENT CO PTY ACN 001 589 439 LTD

Unit 5/28 Leighton Place Telephone: (02) 9476 2244 www.aicpl.com.au
Hornsby NSW 2077 Australia Facsimile: (02) 9476 2902 E-mail: sales@aicpl.com.au

Quality
Endorsed
Company



AS/NZS
ISO 9001
Lic. No.
QEC 6187
Standards
Australia

Table of Contents

Table of Contents	2
Introduction	3
Mechanical Installation	4
Electrical Installation	5
Explanation of Functions	6
Function table	7
Setting up the Instrument.	8
Step 1, Entering the setup mode.	8
Step 2, Stepping through the settings.	8
Step 3, Making changes to the settings..	8
Remote Input Functions	9
Calibration & Scaling	10
Calibration (by applying input signals)	10
Input Scaling (By keying in scaling values)	10
Uncalibration	10
Returning to the normal measure mode	10
Specifications	11
Technical Specifications	11
Physical Characteristics	11
Guarantee and Service	12

1 Introduction

This manual contains information for the installation and operation of the TP4-LP Monitor. The TP4 loop powered display is a general purpose instrument which accepts an input of 4 to 20 mA DC. The instrument may be calibrated to display the input in engineering units. The intelligent microprocessor provides features such as display rounding and digital filtering (improves stability by reducing susceptibility to noisy signals).

Unless otherwise specified at the time of order, your TP4 has been factory set to a standard configuration. Like all other TP4 series instruments the configuration and calibration is easily changed by the user, by push button functions.

The Instrument is totally powered by the 4 to 20mA loop and requires no additional power supply. Since the TP4 requires a 3 volt max loop voltage drop, it is especially suitable for current loops that would otherwise exceed their power supply capacity with too many devices connected.

The versatile TP4 may be scaled over the entire display range without the need to select components or select internal links. The pushbutton functions provide easy programming of decimal point, digital filter, display rounding (resolution) and calibration.

The TP4 series of Weatherproof/Wallmount Monitors are designed for high reliability in industrial applications. The high contrast LCD displays provide good visibility especially in areas with high ambient light levels. Two display types are available, the 4 digit display has 25.4mm high digits, whilst the 4½ digit display has 20mm high digits.

2 Mechanical Installation

The instrument is designed to be wall mounted. Carefully measure and drill 4 x mounting holes (max 5mm diameter) as shown below.

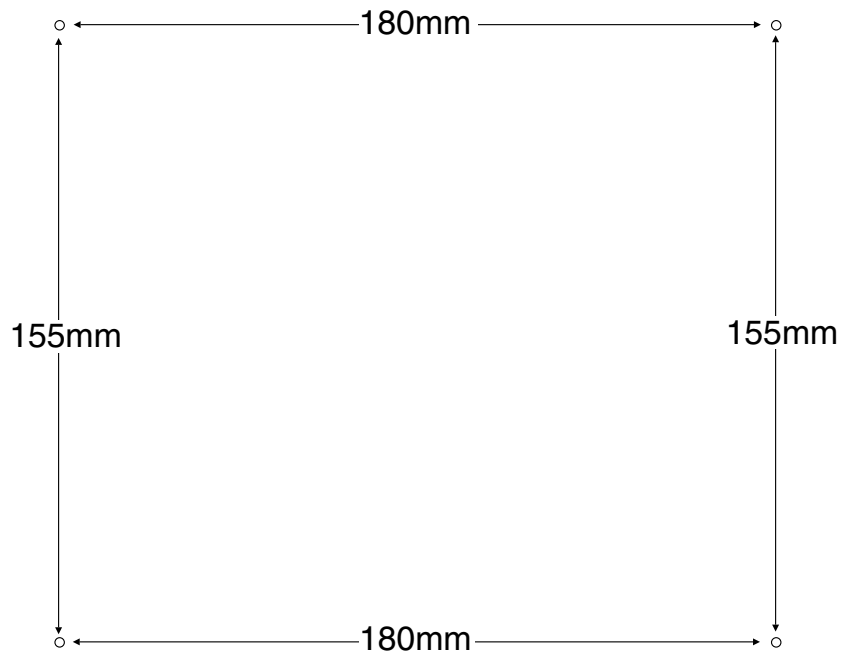
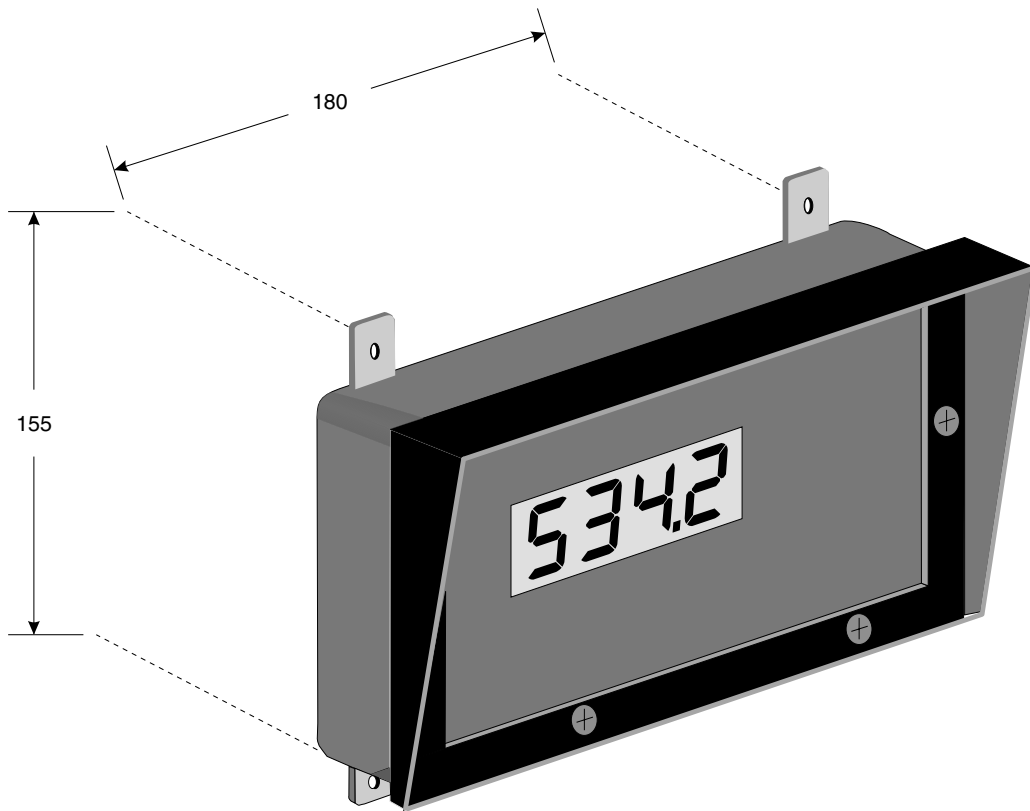

3 Electrical Installation

To install cables remove six (6) front panel retaining screws. Remove front panel to gain access to circuit board and terminal connectors. Insert cables through the cable gland fitted to the base of the enclosure (unless ordered without cable gland) and connect cables to the terminal block(s) located on the printed circuit board. The terminal are clearly labeled, please take care to connect correctly. The terminal blocks allow for wires of up to 2.5mm² to be fitted.

Since the instrument derives its power from the 4-20mA loop, a terminal (marked "LOOP N/C") is provided for joining loop cables.

Terminal are also provided for connection of an optional remote input switch, which may be used to perform special functions such as peak hold (see section on "Remote Input Functions").

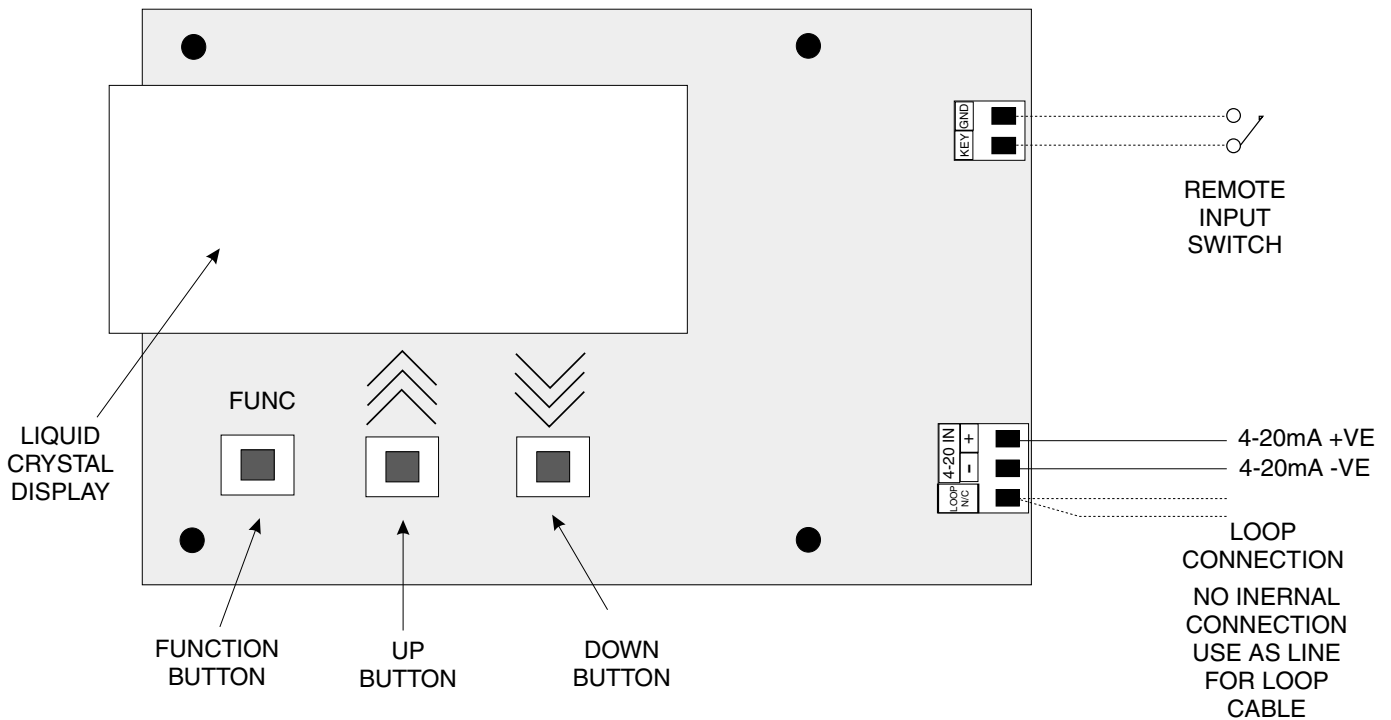

4 Explanation of Functions

The TP4 setup and calibration functions are configured through a pushbutton sequence, as explained in “setting up the instrument” and “calibration”. Two levels of access are provided for setting up and calibrating - level 1 (simple pushbutton sequence) allows access to commonly set up functions, level 2 (power up sequence plus pushbutton sequence) allows access to calibration parameters. Note; Changes to the functions are made by pressing the **▲** and **▼** pushbuttons. Described below is a brief description of each function.

Set up functions (see also chapter titled “Setting up the instrument”).

To enter the set up mode, a simple pushbutton sequence is necessary (this prevents accidental alteration of settings). First press the **F** button and then (within 2 seconds) press both the **▲** and **▼** pushbuttons simultaneously. The display will now read **FUNC** thereby indicating that you have entered the Function Setup Mode. Each function may be accessed by pressing the **F** pushbutton to step through the functions as indicated below.

d r o u n d (display rounding).

Displays and sets the display rounding value. This value may be set to 0 - 5000 displayed units. Display rounding is useful for reducing the instrument resolution without loss of accuracy, in applications where it is undesirable to display to a fine tolerance (e.g. if set to **10** the instrument will display in multiples of 10).

d e c i m a l (decimal point selection).

Displays and sets the decimal point. By pressing the **▲** or **▼** pushbuttons the decimal point position may be set. The display will indicate as follows: **0** (no decimal point), **0. 1** (1 decimal place), **0.002** (2 decimal places), **0.0003** (3 decimal places).

F i l t e r (digital filter)

Displays and sets the digital filter value. Digital filtering is used for reducing susceptibility to short term interference. The digital filter range is selectable from 0 to 8, where **0** = none and **8** = most filtering. A typical value for the digital filter would be 3.

S P F F n (special function)

Displays and sets the special function input selection (see “Remote Input” chapter) . May be set to any one of the following: none **NONE**, peak hold **PHLD**, display hold **dHLD**, peak memory **M1** or valley memory **LD**. The selected special function is actuated by a remote contact closure between the terminals marked “KEY” and “GND”.

S q r t (square root)

Selects the square root calibration to **ON** or **OFF**. When set to **ON** a square root function is applied to the calibrated input. When set to **OFF** the calibration is a linear function.

Calibration functions (See also chapter titled “Calibration”).

To enter this mode a special “power up procedure must be followed” this procedure prevents accidental alteration of calibration and provides a degree of calibration security.

Turn off the instrument power.

Press and hold the **F** button whilst applying power to the instrument. The instrument will display **CAL** indicating that the calibration level of the function mode may be accessed. Now enter the function set up mode as described above “entering the set up mode” and step through the functions until the display indicates **CAL 1**.

CAL 1 & CAL 2 (calibration by applying an input signal)

Displays and sets the two independent calibration/scaling points of the input to the display. See “Calibration” chapter for full details of setting up. Enter **CAL 1** input value, **SCAL 1** scaling/displayed value, then enter **CAL 2** input value and **SCAL 2** scaling/displayed value. The calibration of these points may also be carried out as independent operations.

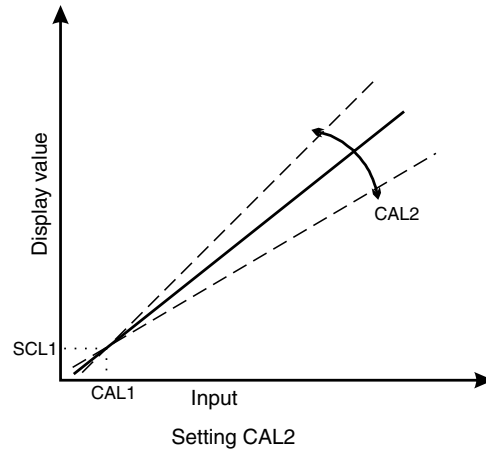
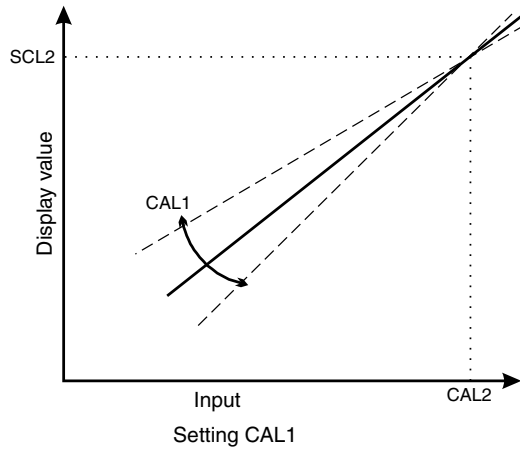

OFFSE (offset calibration)

Allows the instrument calibration to be offset by a single point value. This value is added or subtracted across equally the range of the instrument.

SCALE (Input scaling by keying in 4 to 20mA values)

The instrument may be calibrated without using test equipment (on the 4 to 20mA input only). The display reading at 4mA and at 20mA are programmed in as scaling values.

UCAL (uncalibration).

Used to set the instrument back to the factory calibration values. This function should only be used when calibration problems exist, and it is necessary to clear the calibration memory.

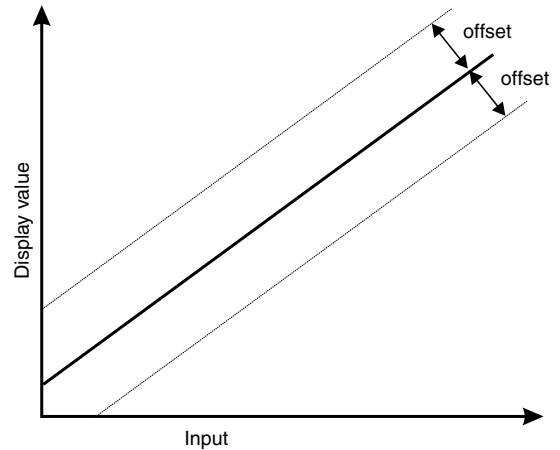

Important: When the calibration procedure has been completed, it is advisable to return the instrument to the normal mode (where calibration functions cannot be tampered with) To return to the normal mode, turn off power to the instrument, wait a few seconds and then restore power.

4.1 Function table

Initial display	Meaning of display	Next display	Record your settings
drnd	Display Rounding Selects Resolution	Last value in Memory	
dCPt	Display Decimal Point	Decimal Pt Position 0. 1.00.02 or 0.003	
FLtR	Digital Filter Range 0 to 8	0 to 8 (8=most filtering)	
SPFN	Special Function	NONE PHLd dHLd Hi LO	
SQRt	Select Square Root	ON or OFF	
CAL 1	Calibration by applying an input signal	See section on calibration/scaling	
OFFSE	Offset calibration	Last value in Memory	
SCALE	Scaling by keying in 4-20mA values	See section on calibration/scaling	
UCAL	Uncalibration resets calibration	See section on calibration/scaling	

5 Setting up the Instrument

Setting up and calibrating the TP4 is extremely easy, since most functions are changed or viewed by pressing the pushbuttons.

5.1 Step 1, Entering the setup mode.

To enter the setup mode, a simple pushbutton sequence is necessary (this prevents accidental alteration of settings). First press the **F** button and then (within 2 seconds) press both the **▲** and **▼** buttons simultaneously. The display will now read **FUNC** thereby indicating that you have entered the Function Setup Mode.

5.2 Step 2, Stepping through the settings.

The display of **FUNC** is followed by the first setup message **drnd** (this means display rounding and is used to set the display resolution). As with all other messages the first display lets you know which parameter will be affected when changes are made. Each time the **F** button is pressed another setup parameter is displayed until you reach the last function when the display returns to reading the normal process display.

5.3 Step 3, Making changes to the settings.

Whilst still in the Function Setup Mode, press the **F** button until you reach the parameter you wish to change. Initially the display will indicate the particular function (e.g. **dCPt** decimal point), this will be followed by a display showing the current status of that setting (e.g. **0.003** 3rd decimal point from the left). The setting may now be changed by pressing the **▲** or **▼** pushbutton until the desired value is displayed. You may then proceed through the functions until you reach the next function that you wish to change or until you exit the function mode. See next page for full list/chart of programmable functions.

Note: to calibrate the instrument refer to calibration chapter.

6 Remote Input Functions

The TP4 remote input allows the operation of a special function via a voltage free contact to the instrument terminal block (terminals marked “KEY” and “GND”). The input is either a bi-state contact closure (toggle switch, PLC or other external switch) or a momentary pushbutton contact. The instrument may be configured to perform any one of the following functions:

- None
- Peak Hold
- Display Hold
- Peak Memory (Max)
- Valley Memory (Min)

NONE (None)

This function is selected when none of the special functions are required.

PHLD (Peak Hold)

This function displays and holds the peak reading, when the contact input is closed. When the contact is open the display indicates the live reading.

DHLD (Display Hold)

The display hold function is similar to peak hold, except that the held reading is the value displayed when the switch contact is closed.



HI (Peak Memory)

The peak memory (max) is displayed when the pushbutton contact is closed momentarily. The display returns to the normal display after 20 seconds. To reset the peak memory the button must be held closed for 1 to 2 seconds.

LD (Valley Memory)

The valley memory (min) operates in a similar way to the peak memory.

Selecting the remote input function

To select the required function, enter the setup mode in the usual way (see “Setting up the Instrument”) and step through the functions until you reach the display message ***SPFN*** (special function). Use the  and  buttons select the required function.

Note: This special function mode is inhibited for 20 seconds after power is initially applied on to allow the system to stabilise.

7 Calibration & Scaling

To enter the calibration mode a special “power up procedure” must be followed. This procedure prevents accidental alteration of calibration and provides a degree of calibration security. In calibration mode the user will have access to all setup and calibration functions. Follow the procedure show in the diagram below to enter calibration mode.

7.1 Calibration (by applying input signals)

When using this method of calibration two input signals (**CAL 1** and **CAL 2**) are placed one at a time at the input. Corresponding display values are then entered (**SEL 1** after **CAL 1** and **SEL 2** after **CAL 2**).

To enter this mode, step through the functions until the display shows **CAL 1** then press the **▲** and **▼** buttons simultaneously. The display will now flash **CAL** followed by a “live” reading from the input, do not worry if the live reading is not as expected.

*Apply a known input to the instrument of nominally 4mA (or 10mA if 10-50mA input selected), this value is not critical and may be anywhere within the measuring range of the instrument. When the reading has stabilised press the **F** button. The display will indicate **SEL 1** (scale 1) followed by the last scale value in memory. Now press the **▲** or **▼** button to obtain the required scale (calibration) value, this is the value which will be displayed whenever that current level is present.

Press the **F** button, the display will now indicate **CAL 2** (2nd calibration point) press the **▲** and **▼** buttons simultaneously. Apply an input of 20mA (or 50mA if 10-50mA input selected), again this value is not critical, for best accuracy it should not be too close to the previous value. Again a “live” reading will be seen ,when the reading has stabilised, press the **F** button, the display will now read **SEL 2** (scale 2) followed by the second scale value in memory. Press the **▲** or **▼** button to obtain the required scale value, this is the value which will be displayed whenever the second current value is seen.

Press and release the **F** button, the display will now read **CAL End** indicating that the calibration is complete. The display will return to the measure mode (with calibration access).

* “Apply a known input” refers to either a simulated or real input. Since the TP4-LP is intended for use with various transmitters, the known input may take the form of an actual process change at the transmitter or a suitable electronic 4 to 20mA (or 10-50mA) current simulator etc.

7.2 Input Scaling (By keying in scaling values)

This method is an alternative to the live input method of scaling. The scale values for 4 and 20mA (or 10 and 50mA if selected) are simply entered. To enter this function firstly enter calibration mode (by holding **F** whilst applying power), then function mode (by pressing and releasing **F** then pressing **▲** and **▼** simultaneously). Step through the functions until the display indicates **SCALE** (input scaling) press then release the **▲** and **▼** buttons simultaneously. The display will now indicate **EN 4** (enter 4mA scaling value), or **EN 10** if a 10-50mA input has been selected, followed by the last scaling value in memory. Using the **▲** or **▼** button set the display to the required reading for 4mA (or 10mA). Now press the **F** button. The display will indicate **EN 20** (enter 20mA scaling value), or **EN 50** if a 10-50mA input has been selected, followed by the last scale value in memory. Now press the **▲** or **▼** button to obtain the required display reading for 20 mA(or 50mA). Press the **F** button the display will now read **CAL End** indicating that the calibration/scaling is complete. The display will return to the measure mode (with calibration access).

7.3 Uncalibration

The uncalibrate (**UNCAL**) function sets the instrument back to the factory calibration value. The factory calibration is nominally a display of 1000 for the full scale input of 20mA (or 50mA) and 0 for 20mA (or 10mA). This function only needs to be used when when a calibration error exists due to incorrect calibration. The uncalibrate mode follows the calibration mode, described above and is initialised by pressing the **▲** and **▼** buttons simultaneously when **UNCAL** is displayed (note this function will delete the existing calibration values and should only be used when necessary). The display will show **CAL CLR** indicating that the calibration memory is cleared and has returned to factory default settings. The display will return to the measure mode (with calibration access).

7.4 Returning to the normal measure mode

When the calibration procedure has been completed, it is advisable to return the instrument to the normal mode (where calibration functions cannot be tampered with). To return to the normal mode, turn off power to the instrument, wait a few seconds and then restore power.

8 Specifications

8.1 Technical Specifications

Input:	4 to 20mA
Loop Voltage Drop:	3V nominal
Current Range:	Measurable range 3.5 to 22mA
Input Protection:	150mA in either direction
Impedance:	3 volts + 18Ω
Display Range:	4 digit - 1999 to 9999 4½ digit - 1999 to 1999
Decimal Points:	19.999, 199.99 or 1999.9 selectable
Calibration Range:	Anywhere within the instrument display range
Overrange Indication:	- - - - on display
ADC resolution:	1 in 40,000
Accuracy:	0.025% of full scale, when calibrated
Display Update:	4 per second
Conversion Method:	Residue multiplication analog to digital conversion method
Microprocessor:	MC1468HC05C8 CMOS
Ambient Temperature:	-10 to 60°C
Humidity:	5 to 95% non condensing
Display:	4 digit 25.4mm liquid crystal display 4½ digit 20mm liquid crystal display
Power Supply:	Powered by the 4 to 20mA loop power

8.2 Physical Characteristics

Case Size:	255w x 145h x 125d (mm approx.)
Wall Mounting:	Hole pattern - 180mm x 155mm
Panel Cut Out:	(Optional 240mm x 130mm)
Connections:	Plug in screw terminals (max. 1.5mm wire)
Weight:	1 kg unpacked

9 Guarantee and Service

The product supplied with this manual is guaranteed against faulty workmanship for a period of 2 years from the date of dispatch.

Our obligation assumed under this guarantee is limited to the replacement of parts which, by our examination, are proved to be defective and have not been misused, carelessly handled, defaced or damaged due to incorrect installation. This guarantee is VOID where the unit has been opened, tampered with or if repairs have been made or attempted by anyone except an authorised representative of the manufacturing company.

Products for attention under guarantee (unless otherwise agreed) **must be returned to the manufacturer freight paid** and, if accepted for free repair, will be returned to the customers address in Australia free of charge.

When returning the product for service or repair a full description of the fault and the mode of operation used when the product failed must be given.

In any event the manufacturer has no other obligation or liability beyond replacement or repair of this product.

Modifications may be made to any existing or future models of the unit as it may deem necessary without incurring any obligation to incorporate such modifications in units previously sold or to which this guarantee may relate.

This document is the property of the instrument manufacturer and may not be reproduced in whole or part without the written consent of the manufacturer.
This product is designed and manufactured in Australia.