

**Model RM4-TR
Totaliser/Ratemeter
DIN Rail Process Monitor/Controller
Operation and Instruction Manual**

AMALGAMATED INSTRUMENT CO PTY LTD

ABN: 80 619 963 692

*Unit 5, 28 Leighton Place Hornsby
NSW 2077 Australia*

*Telephone: +61 2 9476 2244
Facsimile: +61 2 9476 2902*

*e-mail: sales@aicpl.com.au
Internet: www.aicpl.com.au*

Table of Contents

1	Introduction	3
2	Mechanical installation	6
3	Electrical installation	7
4	Function table - for rate/frequency only display	15
5	Function table - for totaliser only display	18
6	Function table - for total and rate/frequency	22
7	Explanation of functions	26
8	Specifications	48
9	Guarantee and service	49

1 Introduction



1.1 General description

This manual contains information for the installation and operation of the RM4-TR Monitor. The instrument may be set to operate as a ratemeter or totaliser or allow toggling between rate and total displays.

The **SEt OPEr** function allows selection of one of these three modes. A brief description of each mode is given below. The three modes of operation are:

1. **totl** - totaliser/counter display. The input pulses are totalised, scaled in engineering units and displayed e.g. a display showing Total litres, mm etc. Count up or count down operation is possible via the SET electrical input and is controlled by the **SlRP** function. A total and grand total may be viewed and reset separately. The grand total is a separate total memory which adds together all the previous totals. Explanation and examples of the totaliser functions are given in the “Totaliser Explanation of Functions” chapter.

2. **FFeQ** - frequency/rate display. The frequency or rate of the input may be scaled in engineering units and displayed e.g. a display showing R.P.M, Bottles/min., Litres/hour etc.. For low frequency inputs (input always below 1kHz) there is an option of displaying either rate or period. Explanation and examples of the ratemeter functions are given in the “Ratemeter Explanation of Functions” chapter.

3. **both** - total/rate display (display may be toggled to either total or rate) This mode is primarily used when the display is required to toggle between a rate and total display via an external contact closure or via the front panel  and  buttons (only fitted on certain display options). For low frequency inputs (input always below 1kHz) there is an option of toggling between rate/total or rate/period. A total and grand total may be viewed and reset separately.

Note: modes **PERd** and **S.Pr-d** seen at the **SEt OPEr** function are not covered in this manual, see separate RM4-TMR manual. Two standard inbuilt relays provide alarm/control functions. A standard transmitter supply of 5VDC or 24VDC (link selectable) unregulated is also provided on both AC and DC powered models. Various combinations of one or two optional extra relays, analog (4-20mA, 0-1V or 0-10V) retransmission or serial (RS232, RS485 or RS422) communications and an isolated 12 or 24VDC isolated transmitter supply may also be provided as an option.

Unless otherwise specified at the time of order, your RM4 has been factory set to a standard configuration. Like all other RM4 series instruments the configuration and calibration is easily changed by the user. Initial changes may require dismantling the instrument to alter PCB links, other changes are made by push button functions. Full electrical isolation between power supply, input voltage or current and retransmission output is provided by the RM4, thereby eliminating grounding and common voltage problems. This isolation feature makes the RM4 ideal for interfacing to computers, PLCs and other data acquisition devices.

The RM4 series of DIN Rail Process Modules are designed for high reliability in industrial applications. The 5 digit LED display provides good visibility, even in areas with high ambient light levels. A feature of the RM4 is the programmable display brightness function, this allows the unit to be operated with low display brightness to reduce the instrument power consumption and to improve readability in darker areas. To reduce power consumption in normal use the display can be programmed to automatically dim or blank after a set time.

Unless otherwise specified at the time of order, your RM4 has been factory set to a standard configuration. Like all other RM4 series instruments the configuration and calibration is easily changed by the user. Initial changes may require dismantling the instrument to alter PCB links,

other changes are made by push button functions.

Full electrical isolation between power supply, input voltage or current and optional retransmission output is provided by the RM4, thereby eliminating grounding and common voltage problems. This isolation feature makes the RM4 ideal for interfacing to computers, PLCs and other data acquisition devices.

The RM4 series of DIN Rail Process Modules are designed for high reliability in industrial applications. The 5 digit LED display provides good visibility, even in areas with high ambient light levels. A feature of the RM4 is the programmable display brightness function, this allows the unit to be operated with low display brightness to reduce the instrument power consumption and to improve readability in darker areas. To reduce power consumption in normal use the display can be programmed to automatically dim or blank after a set time, the display will return to its normal brightness level if any of the pushbuttons are pressed or if an alarm relay is activated.

1.2 Standard outputs

- Two standard inbuilt relays provides an alarm/control function
- A non isolated transmitter supply selectable as 5V or 24VDC approx. (25mA max.) unregulated is provided.

1.3 Output options

- 1 or 2 extra relays
- Isolated 12 bit analog retransmission (single or dual analog output versions available) configurable for 4–20mA., 0–1V or 0–10V.
- Isolated 16 bit analog retransmission plus extra relay
- 12VDC or 24VDC (link selectable) isolated transmitter supply/excitation voltage (25mA max.). Not to be used with the standard unregulated transmitter supply
- Isolated RS232, RS485 or RS422 serial communications (8 bit ASCII or Modbus RTU)
- Isolated Optional outputs are available in certain combinations e.g. Analog output plus isolated transmitter supply.

1.4 Entry to setup and scaling functions

The RM4 setup and calibration functions are configured through a push button sequence. Two levels of access are provided for setting up and calibrating:-

FUNC mode (simple push button sequence) allows access to alarm relay, preset value and display brightness functions.

CAL mode (power up sequence plus push button sequence) allows access to all functions including calibration parameters. Push buttons located at the front of the instrument are used to alter settings. Once **CAL** or **FUNC** mode has been entered you can step through the functions, by pressing and releasing the **F** push button, until the required function is reached. Changes to functions are made by pressing the **▲** or **▼** push button (in some cases both simultaneously) when the required function is reached.

Entering **CAL** Mode



1. Remove power from the instrument. Hold in the **F** button and reapply power. The display will indicate **CAL** as part of the "wake up messages" when the **CAL** message is seen you can release the button.



2. When the "wake up" messages have finished and the display has settled down to its normal reading press, then release the **F** button.



3. Within 2 seconds of releasing the **F** button press, then release the **←** and **→** buttons together. The display will now indicate **FUNC** followed by the first function.

Note: If step 1 above has been completed then the instrument will remain in this **CAL** mode state until power is removed. i.e. there is no need to repeat step 1 when accessing function unless power has been removed.

Entering **FUNC** Mode

No special power up procedure is required to enter **FUNC** mode.



1. When the "wake up" messages have finished and the display has settled down to its normal reading press, then release the **F** button.



2. Within 2 seconds of releasing the **F** button press, then release the **←** and **→** buttons together. The display will now indicate **FUNC** followed by the first function.

Example: Entering **FUNC** mode to change alarm 1 high function **A 1H**, from **OFF** to **100**

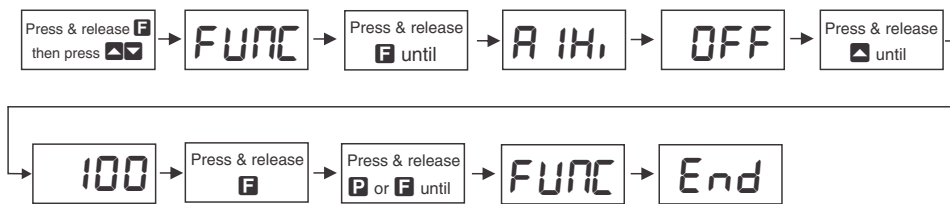

Example: Entering **CAL** mode to change decimal point **dCPT** function from **0** to **0.02**

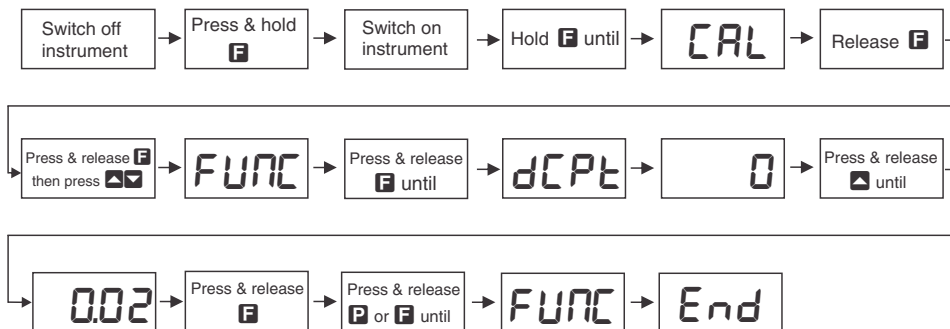

2 Mechanical installation

The instrument is designed for DIN rail mounting. The instrument clips on to 35mm DIN standard rails (EN50022). Cut the DIN rail to length and install where required. To install the instrument simply clip onto the rail as shown below. To remove the instrument lever the lower arm downwards using a broad bladed screwdriver to pull the clip away from the DIN rail.

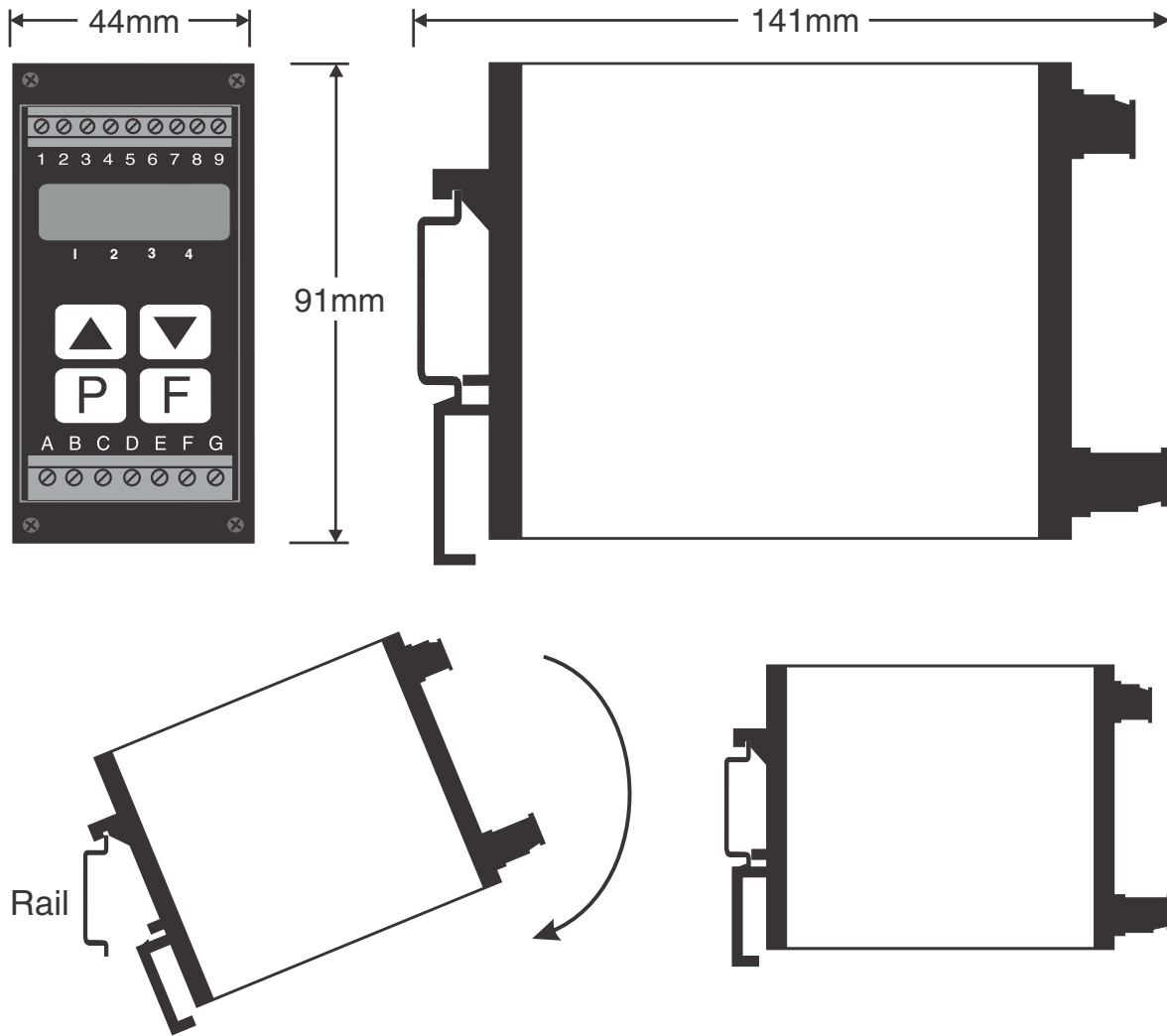

3 Electrical installation

3.1 Electrical installation

The RM4 Panel Meter is designed for continuous operation and no power switch is fitted to the unit. It is recommended that an external switch and fuse be provided to allow the unit to be removed for servicing.

The plug in, screw type, terminal blocks allow for wires of up to 2.5mm² to be fitted for power supply and relays 1 and 2 and 1.5mm² for signal input connections and optional outputs. Connect the wires to the appropriate terminals as indicated below. Refer to connection details provided in this chapter to confirm proper selection of voltage, polarity and input type before applying power to the instrument.

When power is applied the instrument will cycle through a display sequence indicating the software version and other status information, this indicates that the instrument is functioning. Acknowledgement of correct operation may be obtained by applying an appropriate input to the instrument and observing the reading. The use of screened cable is recommended for signal inputs.

For connection details of optional outputs refer to the separate "RM4 Panel Meter Optional Output Addendum" booklet supplied when options are fitted.

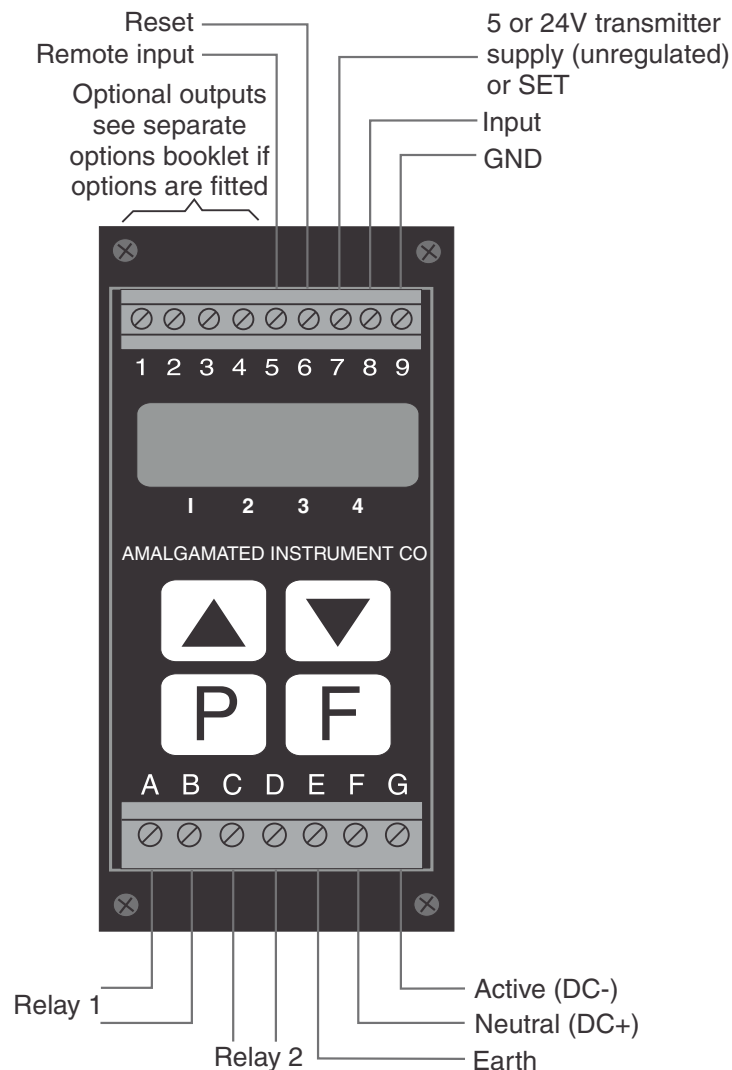

Instrument data label example

A	RELAY 1	COM	1
B	RELAY 1	N/O	2
C	RELAY 2	COM	3
D	RELAY 2	N/O	4
E	MAINS EARTH		5 REMOTE INPUT
F	240VAC NEUTRAL		6 RESET
G	240VAC ACTIVE		7 TRANSMITTER SUPPLY
			8 INPUT +
			9 GND
RM4-TR-240-5E			SERIAL No.

Instrument data label (example)

3.2 Sensor power supply

The standard internal sensor supply may be link selected to provide a regulated 5V or unregulated 24V to power the sensor. The maximum current available is 25mA. The 24V unregulated supplies are only available on the AC powered versions of this panel meter. Note that no more than one link should be fitted i.e. either LK10 or LK11. For 24V sensor supply both LK10 and LK11 should be out and LK16 and LK17 on the main board should be in.

3.3 Count up/down operation

The SET input may be used in up count/down count operation of the totaliser. Control of mode of operation is via the **S.I. NP** function and via the state of the SET input (open circuit or short circuit to ground via link or contact closure). See **S.I. NP** function for description and operation table. If the SET input is to be used LK10 must be in and LK11 out, also LK16 and LK17 on the main board must be out.

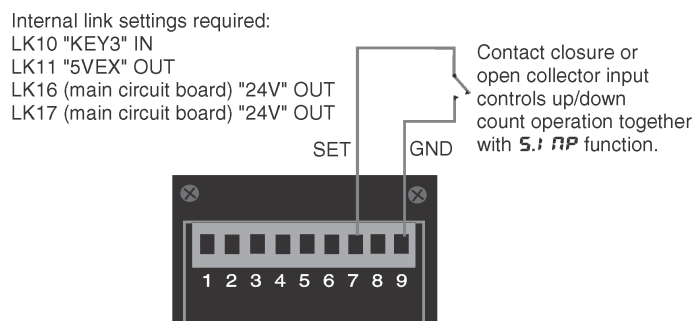

3.4 Relay connections

The RM4 is supplied with two alarm relays as standard. Relay 1 is connected across terminals A and B. Relays 2 is connected across terminals C and D. One or two extra relays are optionally available. Relays 1 and 2 are single pole, single throw types (form A) and are rated at 5A, 240VAC into a resistive load. Relays 3 and 4 are form A rated 0.5A resistive 30VAC or DC. The relay contacts are voltage free and may be programmed for normally open or normally closed operation. If only 3 relays are fitted and no other options are fitted then Relay 3 can be configured as form C via a link on the option board.

3.5 Rotapulse wiring and link settings

The Rotapulse flowmeter is commonly supplied with this model. Wiring and link settings are as shown below:

Rotapulse: Colour code: Black - signal + (terminal 8), Brown - +24V (terminal 7), Blue - ground (terminal 9). Input link settings: Links in are LK2 (BIAS), LK3 (DC), LK4 (HYST), LK9 (VCC), LK16 and 17 (24V links on main board) all other links are out.

3.6 Ext In (Remote input) connections

The remote input connections are across terminals 5 and 9. A momentary or latching voltage free switch can be fitted across these terminals to suit the operation selected at the **RM** function.

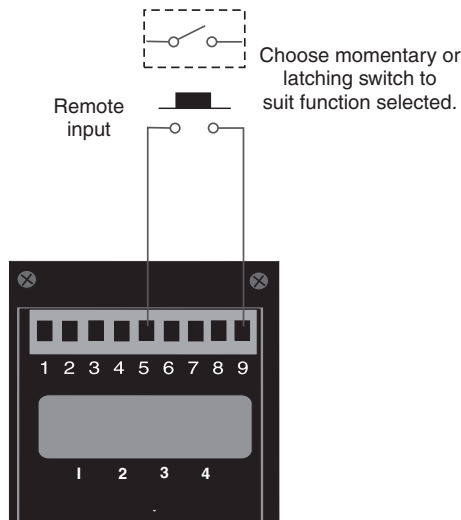

3.7 Input connection and internal link settings

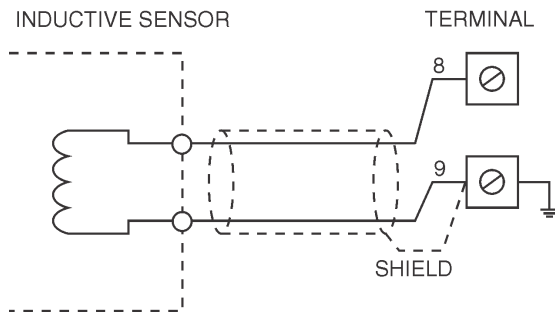

Inductive sensor (48VRMS Max)

Typical internal link settings

LK1	FREQ	See notes
LK2	BIAS	Out
LK3	DC	In
LK4	HYST	See notes
LK5	HYST2	See notes
LK6	GND	See notes
LK7	LOW FREQ	Out
LK8	AC	Out
LK9	VCC	Out

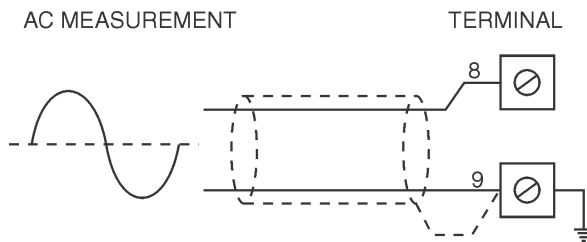

AC Measurement (48VRMS Max)

Typical internal link settings

LK1	FREQ	See notes
LK2	BIAS	Out
LK3	DC	See notes
LK4	HYST	See notes
LK5	HYST2	See notes
LK6	GND	See notes
LK7	LOW FREQ	Out
LK8	AC	Out
LK9	VCC	Out

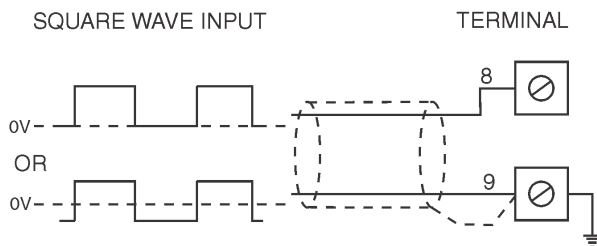

Square wave (48VRMS Max)

Typical internal link settings

LK1	FREQ	Out
LK2	BIAS	See notes
LK3	DC	In
LK4	HYST	See notes
LK5	HYST2	See notes
LK6	GND	See notes
LK7	LOW FREQ	Out
LK8	AC	Out
LK9	VCC	Out

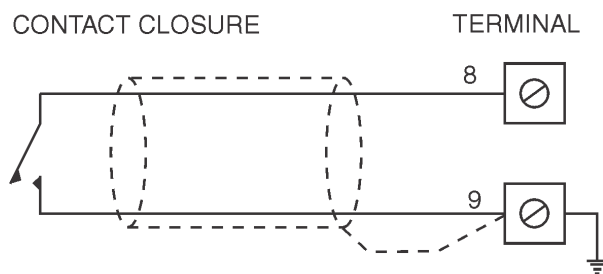

Voltage free contact closure

Typical internal link settings

LK1	FREQ	Out
LK2	BIAS	In
LK3	DC	In
LK4	HYST	In
LK5	HYST2	Out
LK6	GND	Out
LK7	LOW FREQ	In
LK8	AC	Out
LK9	VCC	In

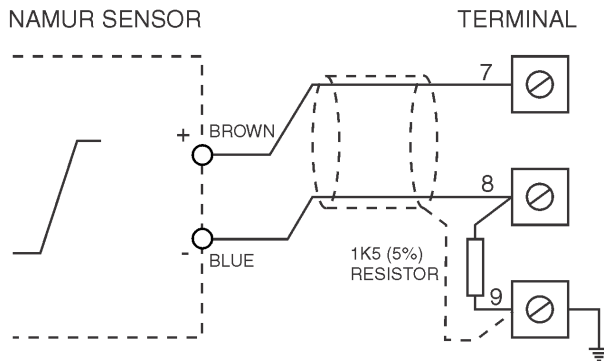

NAMUR Sensor

An external resistor is required for this input type as shown.

Typical internal link settings

LK1	FREQ	Out
LK2	BIAS	In
LK3	DC	In
LK4	HYST	In
LK5	HYST2	Out
LK6	GND	In
LK7	LOW FREQ	Out
LK8	AC	Out
LK9	VCC	Out

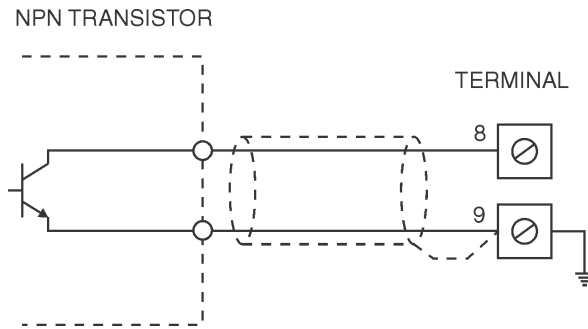

NPN transistor sensor

Typical internal link settings

LK1	FREQ	Out
LK2	BIAS	In
LK3	DC	In
LK4	HYST	See notes
LK5	HYST2	See notes
LK6	GND	Out
LK7	LOW FREQ	Out
LK8	AC	Out
LK9	VCC	In

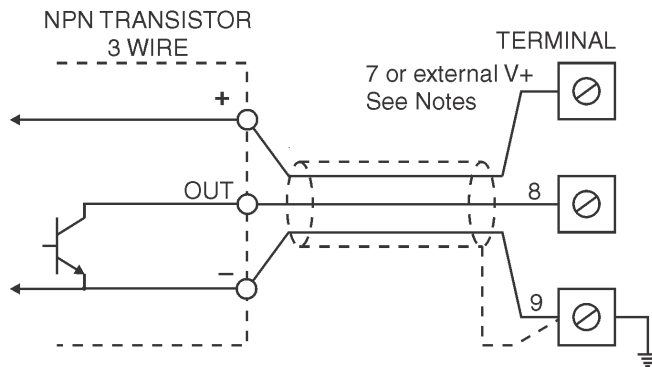

3 wire NPN transistor sensor

Typical internal link settings

LK1	FREQ	Out
LK2	BIAS	In
LK3	DC	In
LK4	HYST	See notes
LK5	HYST2	See notes
LK6	GND	Out
LK7	LOW FREQ	Out
LK8	AC	Out
LK9	VCC	In

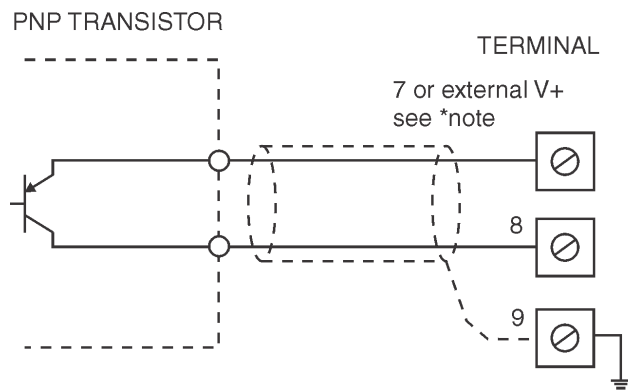

PNP transistor sensor

Typical internal link settings

LK1	FREQ	Out
LK2	BIAS	In
LK3	DC	In
LK4	HYST	See notes
LK5	HYST2	See notes
LK6	GND	In
LK7	LOW FREQ	Out
LK8	AC	Out
LK9	VCC	Out

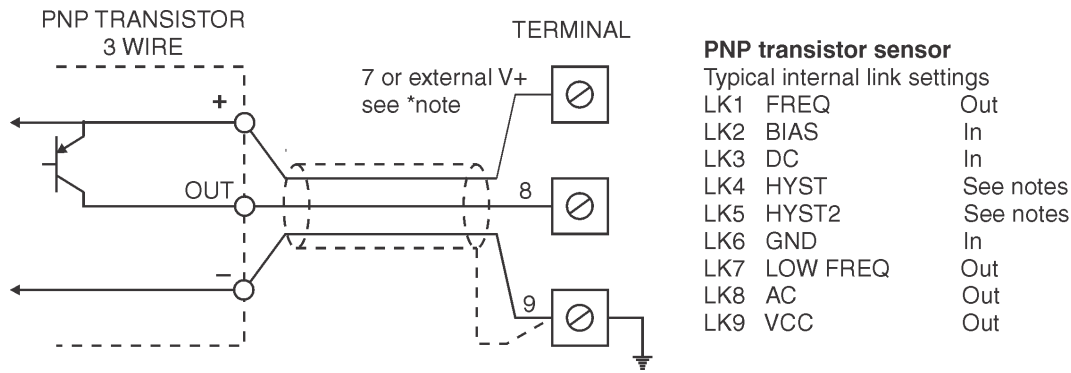

3.8 Notes

The AC link LK8 is only in when the RM4 is to be used to measure the frequency of its own AC supply input, this mode also requires other factory fitted components and is therefore only available when if this mode is specified when ordered. No signal input other than the AC supply is required when this method is used i.e. there is no input to signal fed to terminal 8.

The LOW FREQ link LK7 is primarily provided to filter out contact bounce for voltage free inputs. It can also be used to filter out frequencies above approx. 80Hz in electrically noisy environments when the maximum input frequency is less than approx. 80Hz.

The GND link LK6 and VCC link LK9 should both be out when the input is greater than 24V RMS or 24VDC (48V RMS or 48VDC max. with links removed).

HYST2 link LK5 should be in for signals greater than 1V .HYST link LK4 should be in for signals greater than 5V. For signals lower than 1V both links should be out (100mV minimum signal). A maximum of one hysteresis link should be fitted. The DC coupling link LK3 should be in for frequencies less than 10Hz. The BIAS link LK2 should be in when input signal does not go below 0V.

The FREQ link should generally be left out. It can used when the display is having difficulty registering sinewave AC inputs. If at high frequency (above 10kHz) and with input signals above 2VRMS difficulty is found in obtaining a stable display this link can be tried and it may in some circumstances help to stabilise the display.

3.9 Input circuit diagram

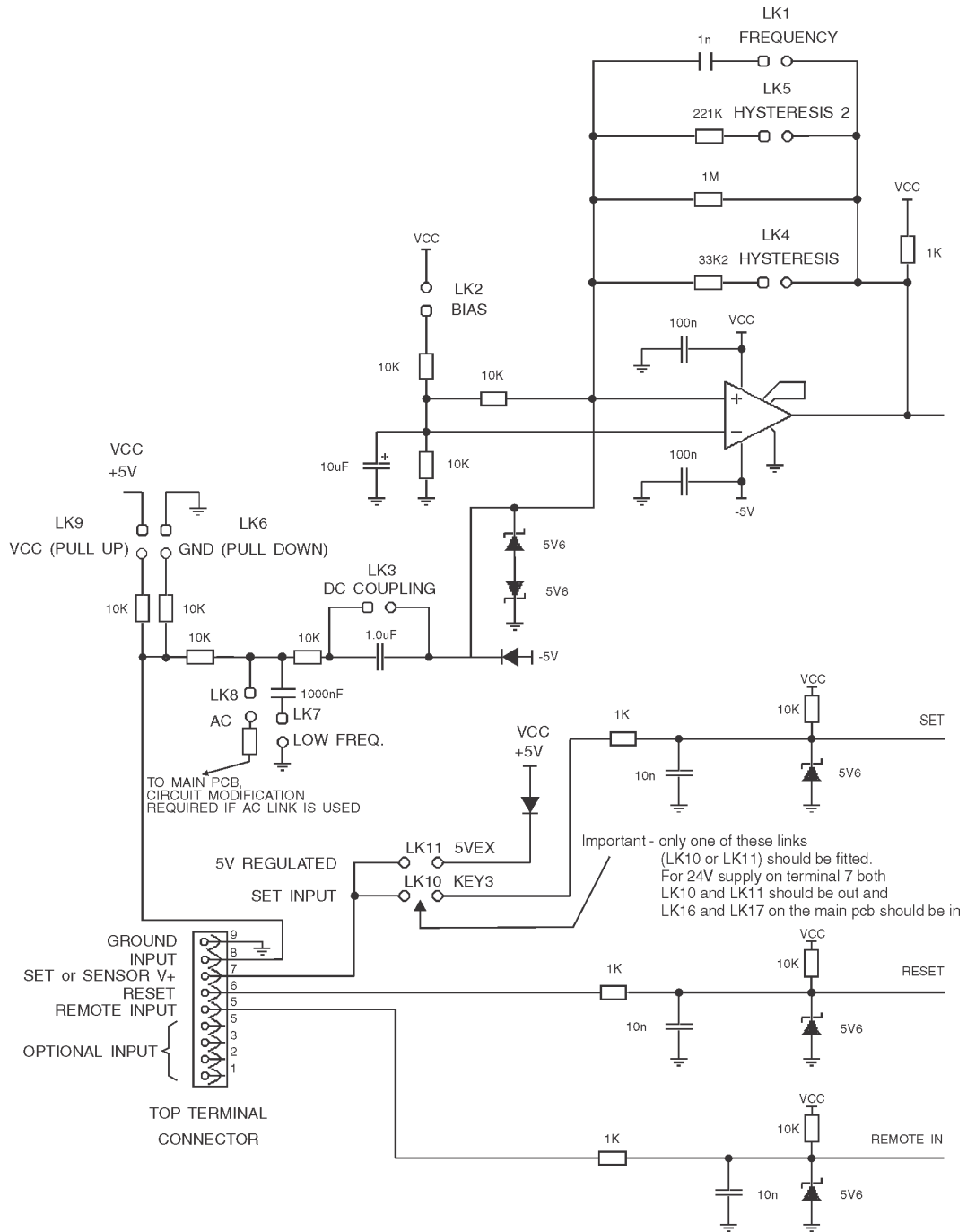

3.10 Configuring the input board

Remove the circuit board from the case following the instructions below. Link settings for the main input board are as shown below. For optional output link settings consult the separate "RM4 DIN Rail Meter Optional Output Addendum" booklet.

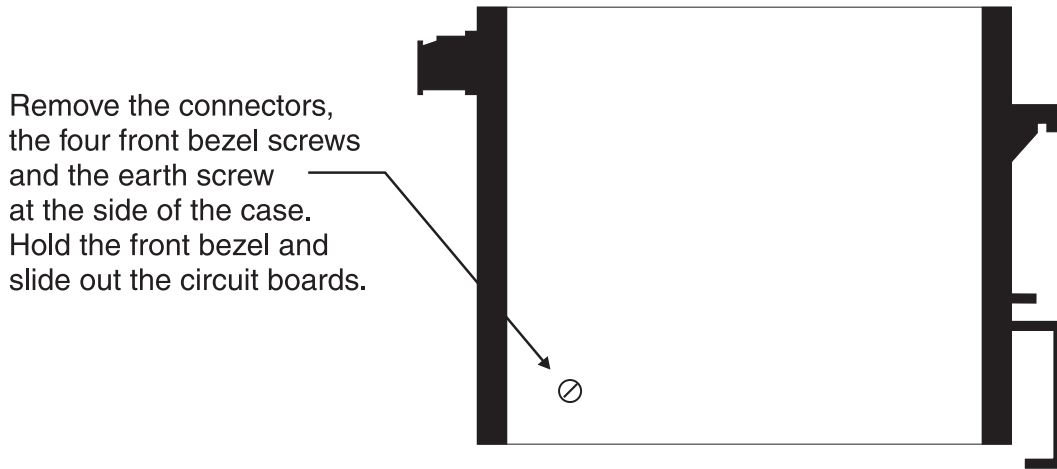

Insert the links into the appropriate location on the pin headers.

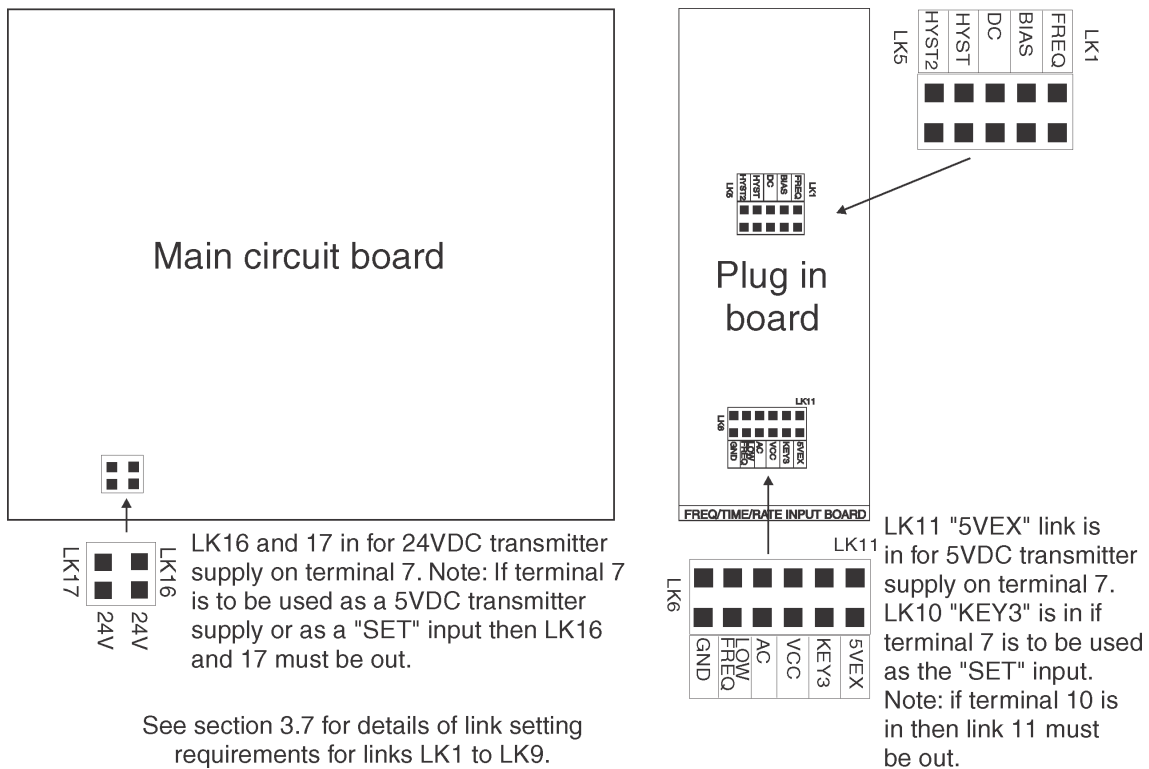

4 Function table - for rate/frequency only display

The function table below shows the functions which will be seen when the **SEt OPEr** function is set to **FFEQ**.

Note: the order in which the functions appear on the display may not be exactly as shown below. The availability and order of functions is determined by choice of function settings and options fitted.

Functions in this first table are available in **FUNC** or **CAL** mode

Display	Function	Range	Default	Your record	Ref/Page
AxLo	Low setpoint value for designated alarm relay <i>x</i>	Any display value or OFF	OFF	See 6.1	7.3 / 28
AxHi	High setpoint value for designated alarm relay <i>x</i>	Any display value or OFF	OFF	See 6.1	7.4 / 28
AxHY	Hysteresis value for the designated alarm relay <i>x</i> .	0 to 9999	10	See 6.1	7.5 / 29
Axtt	Trip time delay for the designated alarm relay <i>x</i> .	0 to 9999	0	See 6.1	7.6 / 30
Axrt	Reset time delay for the designated alarm relay <i>x</i> .	0 to 9999	0	See 6.1	7.7 / 30
Axn.o or Axn.c	Alarm relay <i>x</i> action to normally open (de-energised) or normally closed (energised)	Axn.o or Axn.c	Axn.o	See 6.1	7.8 / 30
AxSP or Axt i etc.	Relay operation independent setpoint or trailing setpoint (*Optional)	AxSP or Axt i etc.	AxSP	See 6.1	7.9 / 31
brgt	Display brightness level	1 to 15	15		7.10 / 31
dull	Display remote brightness switching	0 to 15	1		7.11 / 31
d.oFF SECS	Auto display dimming timer	0 to 9999	0		7.12 / 32

(*Optional)—this function will only be accessible if the relevant option is fitted

Functions in this second table are available only in **CAL** mode or if **ACCs** is set to **ALL**

Display	Function	Range	Default	Your record	Ref/Page
FEC_l	Analog output option low display value (*Optional)	Any display value	0		7.14 / 33
FEC_h	Analog output option high display value (*Optional)	Any display value	1000		7.15 / 33
FEC_l Ch2	Second analog output option low display value (*Optional)	Any display value	0		7.16 / 33

(*Optional)—this function will only be accessible if the relevant option is fitted

FEC⁻ Ch2	Second analog output option high display value (*Optional)	Any display value	1000		7.17 / 33
drnd	Display rounding	1 to 5000	1		7.18 / 34
FLtr	Digital filter	0 to 8	2		7.19 / 34
RAte dCPt	Rate display decimal point selection	0 to number of display digits minus 1	0		7.20 / 34
RAte INPt	Rate input scale factor	Any display value	1		7.21 / 35
RAte SCL	Rate scale factor	Any display value	1		7.22 / 35
PERd dCPt	Period display decimal point selection	0, 0.00.02 etc.	0		7.23 / 35
PERd INPt	Rate input scale factor	Any display value	1		7.24 / 35
PERd SCL	Period scale factor	Any display value	1		7.25 / 36
FRER RNGE	Frequency range	LoF, HiF, AUG or F.AUG	HiF		7.30 / 38
FAST UPdt	Fast update	on or OFF	OFF		7.31 / 39
INPt EDGE	Input edge	RISE or FALL	RISE		7.32 / 39
diSP	Display rate or period	RAte or PERd	RAte		7.33 / 39
diSP RNGE	Period display range	0, 0.01, 0.02 or 0.00.02	0		7.34 / 40
toUt SECS	Rate display time out	1 or 9999	1		7.35 / 40
AUG SECS	Average display seconds	1 or 9999	1		7.36 / 41
RI NP	Remote input function	NONE, P.HLd, d.HLd, Hi, Lo, Hi, Lo, ZEF0, SP.Ac, No.Ac, diSP, duLL or 9.rSt	NONE		7.37 / 41

(*Optional)—this function will only be accessible if the relevant option is fitted

P.but	P button function	<i>NONE, Hi, Lo, Hi, Lo, 2EFG, di SP, FUNC or 9.rSt</i>	<i>NONE</i>		7.38 / 42
ACCS	Access mode	<i>OFF.EASY, NONE or ALL</i>	<i>OFF</i>		7.39 / 42
SPAC	Setpoint access mode (*Optional)	<i>A1, A1-2 etc.</i>	<i>A1</i>		7.40 / 43
SEt OPEr	Set display operation	<i>S.Prd, PErd, FFE9, totL or both</i>	<i>FFE9</i>		7.50 / 46
bAUD rATE	Baud rate for serial communications (*Optional)	<i>300.600. 1200.2400. 4800.9600. 19.2 or 38.4</i>	<i>9600</i>		7.51 / 46
Prty	Parity for serial communications (*Optional)	<i>NONE.EVEN or odd</i>	<i>NONE</i>		7.52 / 46
O.Put	Output for serial communications (*Optional)	<i>di SP.Cont. POLL, A.buS or ā.buS</i>	<i>Cont</i>		7.53 / 46
Addr	Instrument address for serial communications (*Optional)	<i>0 to 31</i>	<i>0</i>		7.54 / 47

(*Optional)—this function will only be accessible if the relevant option is fitted

4.1 Relay table

Record your relay settings in the table below

Display	Relay 1	Relay 2	Relay 3	Relay 4
RxLo				
RxHi				
RxHY				
Rxtt				
Rxrt				
Rxn.o or Rxn.c				
RxSP or Rxt 1 etc.	n/a			
Rxn.o or Rxn.c				

5 Function table - for totaliser only display

The function table below shows the functions which will be seen when the **SEt OPEr** function is set to **totL**.

Note: the order in which the functions appear on the display may not be exactly as shown below. The availability and order of functions is determined by choice of function settings and options fitted.

Functions in this first table are available in **FUNC** or **CAL** mode

Display	Function	Range	Default	Your record	Ref/Page
RxPS	Relay pass value	Any display value	OFF	See 6.1	7.1 / 27
RxPt	Relay pass time	0.0 to 999.9	0.0	See 6.1	7.2 / 27
RxLo	Low setpoint value for designated alarm relay <i>x</i>	Any display value or OFF	OFF	See 6.1	7.3 / 28
RxHi	High setpoint value for designated alarm relay <i>x</i>	Any display value or OFF	OFF	See 6.1	7.4 / 28
RxHy	Hysteresis value for the designated alarm relay <i>x</i> .	0 to 9999	10	See 6.1	7.5 / 29
Rxtt	Trip time delay for the designated alarm relay <i>x</i> .	0 to 9999	0	See 6.1	7.6 / 30
RxrT	Reset time delay for the designated alarm relay <i>x</i> .	0 to 9999	0	See 6.1	7.7 / 30
Rxn.o or Rxn.c	Alarm relay <i>x</i> action to normally open (de-energised) or normally closed (energised)	Rxn.o or Rxn.c	Rxn.o	See 6.1	7.8 / 30
RxSP or Rxt 1 etc.	Relay operation independent setpoint or trailing setpoint (*Optional)	RxSP or Rxt 1 etc.	RxSP	See 6.1	7.9 / 31
brgt	Display brightness level	1 to 15	15		7.10 / 31
dull	Display remote brightness switching	0 to 15	1		7.11 / 31
d.oFF SECS	Auto display dimming timer	0 to 9999	0		7.12 / 32

(*Optional)—this function will only be accessible if the relevant option is fitted

Functions in this second table are available only in **CAL** mode or if **ACCS** is set to **ALL**

Display	Function	Range	Default	Your record	Ref/Page
P.SET	Preset value	Any display value	0		7.13 / 32
FEC₋	Analog output option low display value (*Optional)	Any display value	0		7.14 / 33
FEC⁺	Analog output option high display value (*Optional)	Any display value	1000		7.15 / 33
FEC₋ CH2	Second analog output option low display value (*Optional)	Any display value	0		7.16 / 33
FEC⁺ CH2	Second analog output option high display value (*Optional)	Any display value	1000		7.17 / 33
TOTI dCPE	Total display decimal point selection	0 to number of display digits minus 1	0		7.26 / 36
TOTI INPE	Total input	Any positive display value	1		7.27 / 36
TOTI SCALE	Total scale	Any display value	1		7.28 / 37
G.TOT	Grand Total	NONE, For, FEU, POS, NEG, ABS or FSt	NONE		7.29 / 37
INPE EDGE	Input edge	RISE or FALL	RISE		7.32 / 39
FINP	Remote input function	NONE, P.HLd, d.HLd, Hi, Lo, Hi, Lo, ZERO, SP.Ac, No.Ac, di SP, duLL or g.rSt	NONE		7.37 / 41
P.but	P button function	NONE, Hi, Lo, Hi, Lo, ZERO, di SP, FUNC or g.rSt	NONE		7.38 / 42
ACCS	Access mode	OFF, EASY, NONE or ALL	OFF		7.39 / 42
SPAC	Setpoint access mode (*Optional)	A1, A1-2 etc.	A1		7.40 / 43

(*Optional)—this function will only be accessible if the relevant option is fitted

<i>Ax.rE</i>, <i>Ax.tL</i> or <i>Ax.PS</i>	Alarm relay operation mode	<i>Ax.rE</i>, <i>Ax.tL</i> or <i>Ax.PS</i>	<i>Ax.rE</i>		7.41 / 43
<i>rEE</i>	Analog operation mode (*Optional)	<i>rAtE</i> or <i>totL</i>	<i>rAtE</i>		7.42 / 43
<i>rEE2</i>	Second analog operation mode (*Optional)	<i>rAtE</i> or <i>totL</i>	<i>rAtE</i>		7.43 / 44
<i>S.I NP</i>	SET terminal input function	<i>Lo</i> or <i>h, 9h</i>	<i>h, 9h</i>		7.44 / 44
<i>c.rSt</i>	Totaliser counter reset value	<i>ZEFO</i> or <i>PSEt</i>	<i>ZEFO</i>		7.45 / 44
<i>c.rSt</i>	Totaliser counter reset signal	<i>Lo</i>, <i>LoE</i>, <i>H</i>, or <i>H, E</i>	<i>Lo</i>		7.46 / 44
<i>cntr rSt</i>	Totaliser counter reset value	Any display value	<i>0</i>		7.47 / 45
<i>AlH, rSt</i>	Alarm 1 high reset	<i>on</i> or <i>OFF</i>	<i>OFF</i>		7.48 / 45
<i>SEt OPER</i>	Set display operation	<i>S.PrD</i>, <i>PERd</i>, <i>FFe9</i>, <i>totL</i> or <i>both</i>	<i>FFe9</i>		7.50 / 46
<i>baUD rAtE</i>	Baud rate for serial communications (*Optional)	<i>300.600.</i> <i>1200.2400.</i> <i>4800.9600.</i> <i>19.2</i> or <i>38.4</i>	<i>9600</i>		7.51 / 46
<i>Prty</i>	Parity for serial communications (*Optional)	<i>NONE.EVEN</i> or <i>odd</i>	<i>NONE</i>		7.52 / 46
<i>Q.PuE</i>	Output for serial communications (*Optional)	<i>d! SP.Cont.</i> <i>POLL, A.buS</i> or <i>ā.buS</i>	<i>Cont</i>		7.53 / 46
<i>Addr</i>	Instrument address for serial communications (*Optional)	<i>0</i> to <i>31</i>	<i>0</i>		7.54 / 47

(*Optional)—this function will only be accessible if the relevant option is fitted

5.1 Relay table

Record your relay settings in the table below

Display	Relay 1	Relay 2	Relay 3	Relay 4
<i>AxPS</i>				
<i>AxPt</i>				
<i>AxLo</i>				
<i>AxHi</i>				
<i>AxHY</i>				
<i>Axtt</i>				
<i>Axrt</i>				
<i>Axn.o</i> or <i>Axn.c</i>				
<i>AxSP</i> or <i>Axt !</i> etc.	n/a			
<i>Axn.o</i> or <i>Axn.c</i>				

6 Function table - for total and rate/frequency

The function table below shows the functions which will be seen when the **SEt OPEr** function is set to **both**.

Note: the order in which the functions appear on the display may not be exactly as shown below. The availability and order of functions is determined by choice of function settings and options fitted.

Functions in this first table are available in **FUNC** or **CAL** mode

Display	Function	Range	Default	Your record	Ref/Page
RxPS	Relay pass value	Any display value	OFF	See 6.1	7.1 / 27
RxPt	Relay pass time	0.0 to 999.9	0.0	See 6.1	7.2 / 27
RxLo	Low setpoint value for designated alarm relay <i>x</i>	Any display value or OFF	OFF	See 6.1	7.3 / 28
RxHi	High setpoint value for designated alarm relay <i>x</i>	Any display value or OFF	OFF	See 6.1	7.4 / 28
RxHy	Hysteresis value for the designated alarm relay <i>x</i> .	0 to 9999	10	See 6.1	7.5 / 29
RxTt	Trip time delay for the designated alarm relay <i>x</i> .	0 to 9999	0	See 6.1	7.6 / 30
Rxrt	Reset time delay for the designated alarm relay <i>x</i> .	0 to 9999	0	See 6.1	7.7 / 30
Rxn.o or Rxn.c	Alarm relay <i>x</i> action to normally open (de-energised) or normally closed (energised)	Rxn.o or Rxn.c	Rxn.o	See 6.1	7.8 / 30
RxSP or Rxt i etc.	Relay operation independent setpoint or trailing setpoint (*Optional)	RxSP or Rxt i etc.	RxSP	See 6.1	7.9 / 31
brgt	Display brightness level	1 to 15	15		7.10 / 31
dull	Display remote brightness switching	0 to 15	1		7.11 / 31
d.oFF SECS	Auto display dimming timer	0 to 9999	0		7.12 / 32

(*Optional)—this function will only be accessible if the relevant option is fitted

Functions in this second table are available only in **CAL** mode or if **ACCS** is set to **ALL**

Display	Function	Range	Default	Your record	Ref/Page
P.SET	Preset value	Any display value	0		7.13 / 32
FEC-	Analog output option low display value (*Optional)	Any display value	0		7.14 / 33
FEC+	Analog output option high display value (*Optional)	Any display value	1000		7.15 / 33
FEC- Ch2	Second analog output option low display value (*Optional)	Any display value	0		7.16 / 33
FEC+ Ch2	Second analog output option high display value (*Optional)	Any display value	1000		7.17 / 33
drnd	Display rounding	1 to 5000	1		7.18 / 34
FLtr	Digital filter	0 to 8	2		7.19 / 34
RAE dCPt	Rate display decimal point selection	0 to number of display digits minus 1	0		7.20 / 34
RAE iNPt	Rate input scale factor	Any display value	1		7.21 / 35
RAE SCLE	Rate scale factor	Any display value	1		7.22 / 35
PERd dCPt	Period display decimal point selection	0, 0.00.02 etc.	0		7.23 / 35
PERd iNPt	Rate input scale factor	Any display value	1		7.24 / 35
PERd SCLE	Period scale factor	Any display value	1		7.25 / 36
tOtI dCPt	Total display decimal point selection	0 to number of display digits minus 1	0		7.26 / 36
tOtI iNPt	Total input	Any positive display value	1		7.27 / 36
tOtI SCLE	Total scale	Any display value	1		7.28 / 37
g.tot	Grand Total	NONE. For, FEU, POS, NEG, ABS or FSt	NONE		7.29 / 37
FREQ RNGE	Frequency range	LoF, H, F, AU9E or F.AU9	H, F		7.30 / 38
FAST UPdt	Fast update	on or OFF	OFF		7.31 / 39

(*Optional)—this function will only be accessible if the relevant option is fitted

INPE EDGE	Input edge	RISE or FALL	RISE		7.32 / 39
DISP	Display rate or period	FARE or PERd	FARE		7.33 / 39
DISP RNGE	Period display range	0, 0.01, 0.02 or 0.00.02	0		7.34 / 40
ROUT SECS	Rate display time out	1 or 9999	1		7.35 / 40
AUGE SECS	Average display seconds	1 or 9999	1		7.36 / 41
FINP	Remote input function	NONE, P.HLD, d.HLD, H, , Lo, H, Lo, ZEFO, SP.Ac, No.Ac, DISP, duLL or 9.rSt	NONE		7.37 / 41
P.but	P button function	NONE, H, , Lo, H, Lo, ZEFO, DISP, FUNC or 9.rSt	NONE		7.38 / 42
ACCS	Access mode	OFF.EASY. NONE or ALL	OFF		7.39 / 42
SPAC	Setpoint access mode (*Optional)	A1, A1-2 etc.	A1		7.40 / 43
AR.rE, AR.tL or AR.PS	Alarm relay operation mode	AR.rE, AR.tL or AR.PS	AR.rE		7.41 / 43
REC	Analog operation mode (*Optional)	RARE or totL	RARE		7.42 / 43
REC2	Second analog operation mode (*Optional)	RARE or totL	RARE		7.43 / 44
SETNP	SET terminal input function	Lo or h, 9h	h, 9h		7.44 / 44
CRSt	Totaliser counter reset value	ZEFO or PSEt	ZEFO		7.45 / 44
CRSt	Totaliser counter reset signal	Lo, LoE, H, or H, E	Lo		7.46 / 44
CRSt rSt	Totaliser counter reset value	Any display value	0		7.47 / 45
AR.H, rSt	Alarm 1 high reset	on or OFF	OFF		7.48 / 45

(*Optional)—this function will only be accessible if the relevant option is fitted

dFlt diSP	Default display	rALe, PErd or botl	rALe		7.49 / 45
SEt OPEr	Set display operation	S.Pr.d, PErd, FFE9, botL or both	FFE9		7.50 / 46
bAUd rALe	Baud rate for serial communications (*Optional)	300.600. 1200.2400. 4800.9600. 19.2 or 38.4	9600		7.51 / 46
Prty	Parity for serial communications (*Optional)	none.EVEN or odd	none		7.52 / 46
O.Put	Output for serial communications (*Optional)	diSP.Cont. POLL, A.buS or ā.buS	Cont		7.53 / 46
Addr	Instrument address for serial communications (*Optional)	0 to 31	0		7.54 / 47

(*Optional)—this function will only be accessible if the relevant option is fitted

6.1 Relay table

Record your relay settings in the table below

Display	Relay 1	Relay 2	Relay 3	Relay 4
AXPS				
AXPt				
AXLo				
AXH,				
AXHY				
AXtt				
AXrt				
AXn.o or AXn.c				
AXSP or AXt 1 etc.	n/a			
AXn.o or AXn.c				

7 Explanation of functions

Easy alarm relay adjustment access facility

The display has an easy alarm access facility which allows access to the alarm setpoints simply by pressing the **F** button at the front of the instrument. The first setpoint will then appear and changes to this setpoint may be made to this setpoint via the **▲** or **▼** buttons. Press the **F** button to accept any changes or to move on to the next setpoint. The instrument must be set in the manner described below to allow the easy access facility to work:

1. The **FUNC** function must be set to **SPAC** or the **ALCS** function must be set to **EASY**.
2. At least one alarm must have a setpoint, nothing will happen if all the alarm setpoints are set to **OFF**.
3. The **SPAC** function must be set to allow access to the relays required e.g. if set to **A1-2** then the easy access will work only with alarm relays 1 and 2 even if more relays are fitted.
4. The instrument must be in normal measure mode i.e. if the instrument is powered up so that it is in **CAL** mode then the easy access will not function. If in doubt remove power from the instrument, wait for a few seconds then apply power again.
5. If the easy access facility is used then the only way to view or alter any other function settings is to power up via **CAL** mode i.e. there is no entry to **FUNC** mode functions unless the instrument is powered up in **CAL** mode.

Frequency/rate mode operation modes.

This mode is chosen by selecting **FFEQ** at the **SET OPER** function. The ratemeter mode can operate in one of 4 basic ways to give different display options namely:

1. Rate display, high frequency.

If **HI F** is selected at the **FFEQ RANGE** function the instrument acts as a general purpose frequency/ratemeter/tachometer. If a very low frequency (below approx. 4Hz) input is used then **LOF** mode should be selected. At frequencies below 4Hz, if **HI F** is selected, the display may alternate between an actual frequency reading and a zero reading, this is due to the higher sampling rate when **HI F** is selected.

Functions specific to display with **FFEQ RANGE** set to **HI F** with a rate display

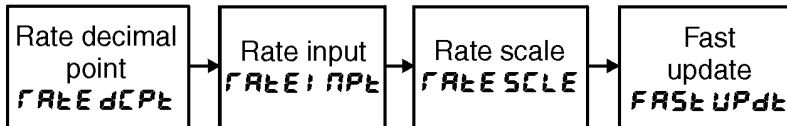

2. Rate display, low frequency.

If **LOF** is selected at the **FFEQ RANGE** function the instrument expects an input frequency of less than 1kHz. This mode allows very low frequency inputs without exhibiting the apparent display instability often seen with low frequency inputs. This display stability is accomplished by allowing the user to set a “time out” value - see the **t.out SECS** function.

Functions specific to display with **FFEQ RANGE** set to **LOF** with a rate display

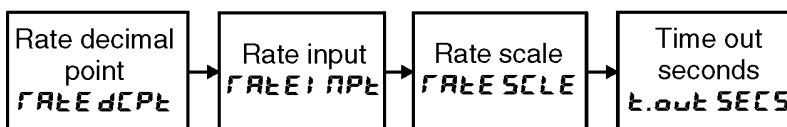

3. Period display, low frequency.

With **LoF** selected at the **FFEQ FNGE** function the user has the option of either displaying the rate (**FRtE**) or period (**PERd**) of the input (chosen via the **d: SP** function). If **PERd** is selected then the display will show the period (or scaled period if required) of the input pulse rather than the rate.

Functions specific to display with **FFEQ FNGE** set to **LoF** with a period display

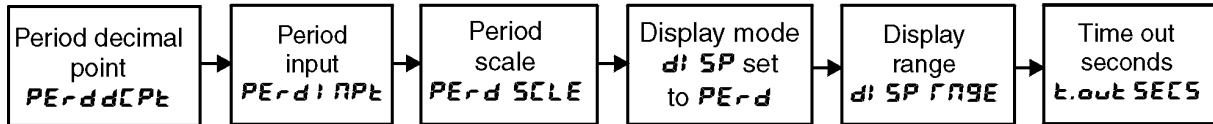

4. Averaged rate display.

With **AUSE** selected at the **FFEQ FNGE** function the display will average the rate input over the number of seconds selected at the **AUSE SECS** function. The display will only update at the end of the averaging period. This mode allows the user to see a steady averaged display for an input which produces short term irregularities.

Functions specific to display with **FFEQ FNGE** set to **AUSE** with an averaged rate display

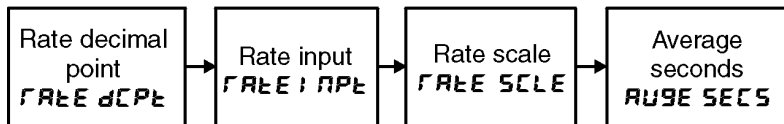

7.1 Relay pass value

Display: **RxPS**
Range: Any display value
Default Value: **OFF**

Alarm relay pass value - only seen when **RxPS** is selected at the **RxtE/RxtL/RxPS** function. Displays and sets the chosen alarm relay (**R1Pt**, **R2Pt** etc.) pass time in seconds. The alarm relay will activate at multiples of the pass value e.g. if **R1PS** is set to **50** then relay 1 will activate at a total display value of **50**, **100**, **150** etc. The time for which the relay remains activated at each pass value is set via the **RxPt** function which follows. The pass value may be set anywhere in the display range of the instrument, positive or negative. The pass value can be set to **OFF** (disabled) by pressing the **▲** and **▼** buttons together.

7.2 Relay pass time

Display: **RxPt**
Range: **0.0** to **999.9**
Default Value: **0.0**

Alarm relay pass time - only seen when **RxPS** selected at the **RxtE/RxtL/RxPS** function. Displays and sets the chosen alarm relay (**R1Pt**, **R2Pt** etc.) pass time in seconds. The value set is the time for which the relay will remain energised when activated at a pass value. e.g. if set to **2.0** with a **R1PS** value of **50** then the relay will remain energised for **2.0** seconds every time the display passes a multiple of **50**. Note: If the pass time exceeds the time taken to reach consecutive

pass values then the instrument will “store” any relay operations it does not have time to activate and will perform these activations when the total display update rate allows. For this reason the relay may be seen to activate repeatedly for a period after the total update rate has slowed down or stopped.

7.3 Alarm relay low setpoint

Display: $RxLo$
Range: Any display value or **OFF**
Default Value: **OFF**

Displays and sets the low setpoint value for the designated alarm relay x . Note x will be replaced by the relay number when displayed e.g. $R1Lo$ for relay 1. Use this low setpoint function if a relay operation is required when the display value becomes equal to or less than the low setpoint value. To set a low alarm value go to the $RxLo$ function and use the \blacktriangle or \blacktriangledown push buttons to set the value required then press **F** to accept this value. The low alarm setpoint may be disabled by pressing the \blacktriangle and \blacktriangledown push buttons simultaneously. When the alarm is disabled the display will indicate **OFF**. If the relay is allocated both a low and high setpoint then the relay will activate when the value displayed moves outside the band set by the low and high setpoints. The value at which the relay will reset is controlled by the $RxHy$ function.

Example:

If $R1Lo$ is set to **10** then relay 1 will activate when the display value is 10 or less.

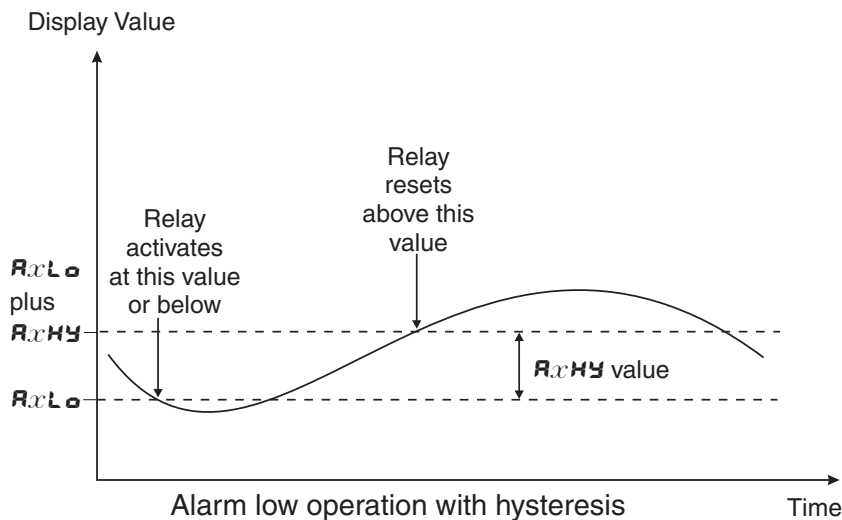

7.4 Alarm relay high setpoint

Display: RxH
Range: Any display value or **OFF**
Default Value: **OFF**

Displays and sets the high setpoint value for the designated alarm relay x . Note x will be replaced by the relay number when displayed e.g. $R1H$ for relay 1. Use this high setpoint function if a relay operation is required when the display value becomes equal to or more than the low setpoint value. To set a high alarm value go to the RxH function and use the \blacktriangle or \blacktriangledown push buttons to set the value required then press **F** to accept this value. The high alarm setpoint may be disabled

by pressing the **▲** and **▼** push buttons simultaneously. When the alarm is disabled the display will indicate **OFF**. If the relay is allocated both a low and high setpoint then the relay will activate when the value displayed moves outside the band set by the low and high setpoints. The value at which the relay will reset is controlled by the **RxHY** function.

Example:

If **A 1H** is set to **100** then relay 1 will activate when the display value is **100** or higher.

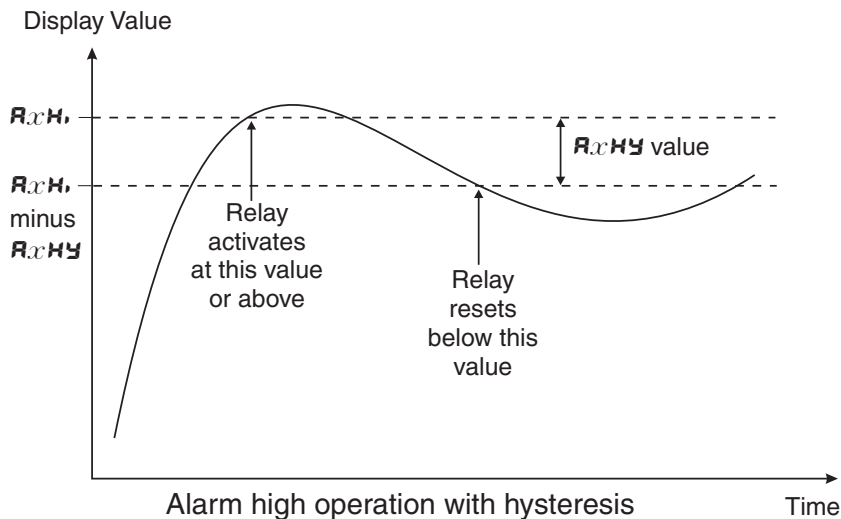

7.5 Alarm relay hysteresis (deadband)

Display: **RxHY**
Range: **0** to **9999**
Default Value: **10**

Displays and sets the alarm relay hysteresis limit for the designated relay *x*. Note *x* will be replaced by the relay number when displayed e.g. **A 1HY** for relay 1. To set a relay hysteresis value go to the **RxHY** function and use the **▲** or **▼** push buttons to set the value required then press **F** to accept this value. The hysteresis value is common to both high and low setpoint values. The hysteresis value may be used to prevent too frequent operation of the relay when the measured value is rising and falling around setpoint value. e.g. if **A 1HY** is set to zero the alarm will activate when the display value reaches the alarm setpoint (for high alarm) and will reset when the display value falls below the setpoint, this can result in repeated on/off switching of the relay at around the setpoint value.

The hysteresis setting operates as follows: In the high alarm mode, once the alarm is activated the input must fall below the setpoint value minus the hysteresis value to reset the alarm. e.g. if **A 1H** is set to **50.0** and **A 1HY** is set to **3.0** then the setpoint output relay will activate once the display value goes to **50.0** or above and will reset when the display value goes below **47.0** i.e. at **46.9** or below. In the low alarm mode, once the alarm is activated the input must rise above the setpoint value plus the hysteresis value to reset the alarm. e.g. if **A 1Lo** is to **20.0** and **A 1HY** is set to **10.0** then the alarm output relay will activate when the display value falls to **20.0** or below and will reset when the display value goes above **30.0** i.e. at **30.1** or above. The hysteresis units are expressed in displayed engineering units.

Example: If **A 1H** is set to **100** and **A 1HY** is set to **10** then relay 1 will activate when the display value is **100** or higher and will reset at a display value of **89** or lower.

7.6 Alarm relay trip time

Display: **Ax.t.t**
Range: **0** to **9999**
Default Value: **0**

Displays and sets the alarm trip time in seconds. The trip time is common for both alarm high and low setpoint values. The trip time provides a time delay before the alarm relay will activate when an alarm condition is present. The alarm condition must be present continuously for the whole trip time period before the alarm will activate. If the input moves out of alarm condition during this period the timer will reset and the full time delay will be restored. This trip time delay is useful for preventing an alarm trip due to short non critical deviations from setpoint. The trip time is selectable over **0** to **9999** seconds. To set a trip time value go to the **Ax.t.t** function and use the **▲** or **▼** push buttons to set the value required then press **F** to accept this value.

Example: If **A 1.t.t** is set to **5** seconds then the display must indicate an alarm value for a full 5 seconds before relay 1 will activate.

7.7 Alarm relay reset time

Display: **Ax.r.t**
Range: **0** to **9999**
Default Value: **0**

Displays and sets the alarm reset delay time in seconds. The reset time is common for both alarm high and low setpoint values. With the alarm condition is removed the alarm relay will stay in its alarm condition for the time selected as the reset time. If the input moves back into alarm condition during this period the timer will reset and the full time delay will be restored. The reset time is selectable over **0** to **9999** seconds. To set a reset time value go to the **Ax.r.t** function and use the **▲** or **▼** push buttons to set the value required then press **F** to accept this value.

Example: If **A 1.r.t** is set to **10** seconds then the resetting of alarm relay 1 will be delayed by 10 seconds.

7.8 Alarm relay normally open/closed

Display: **Axn.o** or **Axn.c**
Range: **Axn.o** or **Axn.c**
Default Value: **Axn.o**

Displays and sets the setpoint alarm relay *x* action to normally open (de-energised) or normally closed (energised), when no alarm condition is present. Since the relay will always open when power is removed a normally closed alarm is often used to provide a power failure alarm indication. To set the alarm relay for normally open or closed go to the **Axn.o** or **Axn.c** function and use the **▲** or **▼** push buttons to set the required operation then press **F** to accept this selection. **Example:** If set to **A 1.n.o** alarm relay 1 will be open circuit when the display is outside alarm condition and will be closed (short circuit across terminals) when the display is in alarm condition.

7.9 Alarm relay setpoint or trailing operation

Display: **RxSP** or **Rxt I** etc.

Range: **RxSP** or **Rxt I** etc.

Default Value: **RxSP**

Relay operation independent setpoint or trailing setpoint, this function only be seen where more than one relay is fitted. Each alarm relay, except relay 1, may be programmed to operate with an independent setpoint value or may be linked to operate at a fixed difference to another relay setpoint, known as trailing operation. The operation is as follows:

Alarm 1 (**R1**) is always independent. Alarm 2 (**R2**) may be independent or may be linked to Alarm 1. Alarm 3 (**R3**) may be independent or may be linked to Alarm 1 or Alarm 2. Alarm 4 (**R4**) may be independent or may be linked to Alarm 1, Alarm 2 or Alarm 3. The operation of each alarm is selectable by selecting, for example, (Alarm 4) **R4.SP** = Alarm 4 normal setpoint or **R4.t I** = Alarm 4 trailing Alarm 1 or **R4.t2** = Alarm 4 trailing Alarm 2 or **R4.t3** = Alarm 4 trailing Alarm 3. For trailing set points the setpoint value is entered as the difference from the setpoint being trailed. If the trailing setpoint is to operate ahead of the prime setpoint then the value is entered as a positive number and if operating behind the prime setpoint then the value is entered as a negative number.

Example: With Alarm 2 set to trail alarm 1, if **R1H** is set to **1000** and **R2H** is set to **50** then Alarm 1 will activate at **1000** and alarm 2 will activate at **1050** (i.e. 1000 + 50). If Alarm 2 had been set at **-50** then alarm 2 would activate at **950** (i.e. 1000 - 50).

7.10 Display brightness

Display: **br9t**

Range: **1** to **15**

Default Value: **15**

Displays and sets the digital display brightness. The display brightness is selectable from **1** to **15**, where **1** = lowest intensity and **15** = highest intensity. This function is useful for improving the display readability in dark areas or to reduce the power consumption of the instrument. See also the **dULL** function. To set brightness level go to the **br9t** function and use the **▲** or **▼** push buttons to set the value required then press **F** to accept this value.

7.11 Display remote brightness switching

Display: **dULL**

Range: **0** to **15**

Default Value: **1**

Displays and sets the level for remote input brightness switching, see **r.I NP** function. When a remote input is set to **dULL** the remote input can be used to switch between the display brightness level set by the **br9t** function 7.10 and the display brightness set by the **dULL** function. The display dull level is selectable from **0** to **15**, where **0** = lowest intensity and **15** = highest intensity. This function is useful in reducing glare when the display needs to be viewed in both light and dark ambient light levels. To set dull level go to the **dULL** function and use the **▲** or **▼** push buttons to set the value required then press **F** to accept this value. The **d.oFF SECS** function

(automatic display blanking or dulling) will also cause the **dULL** function to appear if the **d.oFF SECS** function is enabled i.e. set to any value other than **0**.

Example: With **dULL** set to **4** and **br9t** set to **15** and the **FUNC** function set to **dULL** the display brightness will change from the **15** level to **4** when a switch connected to the remote input terminals is activated.

7.12 Auto display dimming timer

Display: **d.oFF SECS**
Range: **0** to **9999**
Default Value: **0**

This function allows a time to be set after which the display brightness (set by the **br9t** function) will automatically be set to the level set at the **dULL** function. The auto dimming feature can be used to reduce power consumption. The function can be set to any value between **0** and **9999** seconds. A setting of **0** disables the auto dimming. The display brightness can be restored by pressing any of the instruments front push buttons. The display brightness will also be restored whilst one or more alarm relays is activated. In normal display mode (i.e. not in **CAL** mode) there is a 2 minute delay period after the instrument is switched on during which the automatic display dimming will not operate. If any of the front pushbuttons are pressed during this period this 2 minute delay will be canceled.

7.13 Preset value

Display: **P.SEt**
Range: Any display value
Default Value: **0**

A preset value can be entered at this function, for totaliser operation only. If a remote input (**FUNC** function) is programmed to **PSEt** then operation of the remote input will cause the display to change to the preset value. Any change in input from this point will cause a variation above or below the preset value. To set preset value go to the **P.SEt** function and use the **▲** or **▼** push buttons to set the value required then press **F** to accept this value.

The display can also be set to default to the preset value when a reset input is applied. This selection is made at the **crSt** function.



The **P.but** function can be used to change the preset value if this function is set to **FUNC**. This will only normally be used where the preset value is required to be changed regularly.



Example:

With a display showing a value of **50** at a given input if the **P.SEt** function is set to **70** and the remote function is set to **P.SEt** then once the remote input is activated the same input will now have a display value of **70**.

7.14 Analog output option low value



Display: `FEE-`
Range: Any display value
Default Value: `0`



Seen only when analog retransmission option fitted. Refer to the separate “RM4 Din Rail Meter Optional Output Addendum” booklet supplied when this option is fitted for wiring details and link settings. Displays and sets the analog retransmission (4–20mA, 0–1V or 0–10V, link selectable) output low value (4mA or 0V) in displayed engineering units. To set the analog output low value go to the `FEE-` function and use the  or  push buttons to set the required value then press **F** to accept this selection.

Example: If it is required to retransmit 4mA when the display indicates `0` then select `0` in this function using the  or  button.

7.15 Analog output option high value

Display: `FEE^`
Range: Any display value
Default Value: `1000`

Seen only when analog retransmission option fitted. Refer to the separate “RM4 Din Rail Meter Optional Output Addendum” booklet supplied when this option is fitted for wiring details and link settings. Displays and sets the analog retransmission (4–20mA, 1V or 10V) in displayed engineering units. To set the analog output high value go to the `FEE^` function and use the  or  push buttons to set the required value then press **F** to accept this selection.

Example: If it is required to retransmit 20mA when the display indicates `50` then select `50` in this function using the  or  button.

7.16 Second analog output option low value

Display: `FEE- CH2`
Range: Any display value
Default Value: `0`

See `FEE-` function 7.14 for description of operation.

7.17 Second analog output option high value

Display: `FEE^ CH2`
Range: Any display value
Default Value: `1000`

See `FEE^` function 7.15 for description of operation.

7.18 Display rounding

Display: **drnd**
Range: **1** to **5000**
Default Value: **1**

Displays and sets the display rounding value for the rate/frequency display only. This value may be set to 1 - 5000 displayed units. Display rounding is useful for reducing the instrument resolution without loss of accuracy in applications where it is undesirable to display to a fine tolerance. To set the display rounding value go to the **drnd** function and use the **▲** or **▼** push buttons to set the required value then press **F** to accept this selection.

Example:

If set to **10** the rate/frequency display values will change in multiples of 10 only i.e. display moves from **10** to **20** to **30** etc.

7.19 Digital filter

Display: **FLtr**
Range: **0** to **8**
Default Value: **2**

Displays and sets the digital filter value. Digital filtering uses a weighted average method of determining the display value and is used for reducing display value variation due to short term interference. The digital filter range is selectable from **0** to **8**, where **0** = none and **8** = most filtering. Use **▲** or **▼** at the **FLtr** function to alter the filter level if required. Note that the higher the filter setting the longer the display may take to reach its final value when the input is changed, similarly the relay operation and any output options will be slowed down when the filter setting is increased. To set the digital filter value go to the **FLtr** function and use the **▲** or **▼** push buttons to set the required value then press **F** to accept this selection.

7.20 Rate display decimal point selection

Display: **RATE dCpt**
Range: **0** to number of display digits minus 1
Default Value: **0**

Rate decimal point selection - only seen when **FREQ** or **both** mode selected. Displays and sets the decimal point position for the rate display. For example selecting **0** will mean no decimal points (e.g. a display such as **25**), **0.1** means 1 decimal point place (e.g. **2.4**), **0.02** gives 2 decimal point places (e.g. **2.35**) etc. The maximum number of decimal point places is one less than the number of digits on the display e.g. a 4 digit display can have 3 decimal points, a 6 digit display can have 5 decimal points etc. Note: If the number of decimal points is altered then the display scaling figure (**RATE SCALE**) will also be affected. Always check the scaling figure following a decimal point change and alter as required.

7.21 Rate input scale factor

Display: **RATE INPUT**
Range: Any display value
Default Value: 1

Rate input scale factor - only seen when **FREQ** or **both** mode selected. Displays and sets the number of input pulses to be used with the rate scale function to generate the display scaling. See examples later in this chapter and formula below.

7.22 Rate scale factor

Display: **RATE SCALE**
Range: Any display value
Default Value: 1

Rate scale factor - only seen when **FREQ** or **both** mode selected. Displays and sets the scale factor to be used with the rate input setting. See examples later in this chapter. Scale and input work together as follows:

$$\text{Display} = \frac{\text{Input frequency (Hz)} \times \text{RATE SCALE}}{\text{RATE INPUT}}$$

Note: if either the rate input or rate scale factor are set to 0 the scaling will be 1:1 i.e. a 1Hz input will give a display of 1 i.e. it is assumed that there are no scaling factors.

Example: If an encoder sensing revolutions of a shaft puts out 20 pulses per revolution a **RATE INPUT** of 20 and a **RATE SCALE** of 60 will give a display in RPM. Note as the display value is calculated from the ratio between **RATE INPUT** and **RATE SCALE** settings of **RATE INPUT** = 1 and **RATE SCALE** = 3 will give the same result.

7.23 Period display decimal point selection

Display: **PERIOD DCP**
Range: 0, 0.00.02 etc.
Default Value: 0

Period decimal point selection - only seen when **DI SP** function is set to **PERD**. Displays and sets the decimal point for the period display. Note that the decimal point display is tied to the display range (**DI SP RANGE**) function e.g. if the display range function is set to **0.00.02** then the two decimal place setting will show up as **0.00.02** and one decimal place will show as **0.00.1**.

7.24 Period input scale factor

Display: **PERD INPUT**
Range: Any display value
Default Value: 1

Period input scale factor - only seen when **DI SP** function is set to **PERD**. Displays and sets the

number of time period to be used with the period scale function to generate the display scaling. See examples later in this chapter and formula below.

7.25 Period scale factor

Display: **PERD SCL**
Range: Any display value
Default Value: 1

Period scale factor - only seen when **di SP** function is set to **PERd**. Displays and sets the scale factor to be used with the period input setting. To calculate the display value the input frequency and hence the period of this input needs to be known. Scale and input work together to produce a display as follows:

$$\text{Display} = \frac{\text{Input period (seconds)} \times \text{PERD SCL}}{\text{PERDI NPE}}$$

Note: the displayed value is also affected by the decimal point and display range settings.

7.26 Total display decimal point selection

Display: **TOTD CP**
Range: 0 to number of display digits minus 1
Default Value: 0

Total decimal point selection - Displays and sets the decimal point position for the total display. For example selecting 0 will mean no decimal points (e.g. a display such as 25), 0.1 means 1 decimal point place (e.g. 2.4), 0.02 gives 2 decimal point places (e.g. 2.35) etc. The maximum number of decimal point places is one less than the number of digits on the display e.g. a 4 digit display can have 3 decimal points, a 6 digit display can have 5 decimal points etc. Note: If the number of decimal points is altered then the calculated total display be affected. Always check the scaling values following a decimal point change and alter as required.

7.27 Total input scaling factor

Display: **TOTI NPE**
Range: Any positive display value
Default Value: 1

Displays and sets the number of input pulses to be used with the **TOTI SCL** function to generate the required display scaling, see **TOTI SCL** below.

7.28 Total scaling factor

Display: **tot SCALE**
Range: Any display value
Default Value: 1



Displays and sets the scaling factor to be used with the **tot INP** function to generate the required display scaling. The total scale factor can be set to any display value and the decimal point value seen at this function will be set by the **tot dCPE** function. The display value is calculated in the following manner:

$$\text{New total} = \frac{\text{Input pulses counted} \times \text{tot SCALE}}{\text{tot INP}}$$

Example: To scale the display to count total kilolitres with 2 decimal place from an input which gives 10 pulses per litre (i.e. 10,000 pulses per kilolitre) set **tot dCPE** to **0.02**, set **tot INP** to **10000** and set the **tot SCALE** to **1.00** (i.e. display will increment by 0.01 kilolitres for every 100 input pulses and by 1.00 kilolitres for every 10000 input pulses).

7.29 Grand total

Display: **9tot**
Range: **NONE, For, FEU, POS, NEG, ABS** or **rst**
Default Value: **NONE**

Grand total operating mode - By using the  or  pushbutton the display may be toggled between a total or a grand total display (or between rate, total and grand total in **both** mode). The display will briefly show either **rATE**, **tot** or **9tot** to indicate what the following total display is showing. To reset the grand total the remote input must be set to **rst**, see the **rst** function. Six modes of grand total display are provided namely:

NONE - no grand total display
For - Forward
FEU - Reverse
POS - Positive
NEG - Negative
ABS - Absolute
rst - Reset

Mode	Up Count	Down Count
NONE	No effect	No effect
FOR	The grand total will increase with each up count input pulse. The grand total can show positive and negative totals.	The grand total will decrease with each down count input pulse. The grand total can show positive and negative totals.
FEU	The grand total will decrease with each up count input pulse. The grand total can show both positive and negative totals.	The grand total will increase with each down count input pulse. The grand total can show both positive and negative totals.
POS	The grand total will increase with each up count input pulse. The grand total display cannot go negative.	The grand total will not register any down count inputs i.e. the grand total will not change when down count only inputs are present. The grand total display cannot go negative.
NEG	The grand total will not register any up count inputs i.e. the grand total will not change when up count only inputs are present. The grand total display cannot go negative.	The grand total will increase with each down count input pulse. The grand total display cannot go negative.
ABS	The grand total will increase with any input pulse whether up or down count. The grand total display cannot go negative.	The grand total will increase with any input pulse whether up or down count. The grand total display cannot go negative.
FSL	Grand total increments by 1 display unit each time total is reset or zeroed e.g. increments by 1 or 0.1 or 0.01 etc. irrespective of up or down count direction.	

These modes allow a choice of how the grand total will be displayed. The total may be switched between up and down count via the “SET” input and the **SI/DP** function. Ensure that the “SET” link is in before attempting to use this input to change count direction. The following table illustrates each mode of operation.

7.30 Frequency range

Display: **FFEQ FNGE**
Range: **LoF, Hi F, AUSE** or **F.AUG**
Default Value: **Hi F**

Frequency range - Displays and sets the frequency input range.

Select **LoF** if the input frequency is likely to be lower than 4Hz and not greater than 1kHz.

Select **Hi F** for frequencies with a minimum input frequency of 3Hz or higher (maximum input frequency is 100kHz).

Note that the period display (in **both** or **FFEQ** modes) will only be accessible when the frequency range is set to **LoF** and hence the input frequency must not be above 1kHz.

Select **AUSE** for an averaged display. The averaged display allows the input rate to be averaged over a period of seconds set by the **AUSE SECS** function. An averaged display is particularly useful when the input is irregular. By averaging the pulses over a period of time the display will give a more stable reading for these irregular pulses.

Select **F.AUG** for a “rolling averaged” display (note the filter **FLTR** function is not available when this mode is selected). The rolling average allows the frequency/rate reading to be averaged

over a period set by the **AUSE SECS** function but this average is taken over a programmable number of counts set at the **AUSE Cnt** function. For example if the with the **FREQRNGE** function set to **F.AVG** (rolling average), the **AUSE SECS** function set to **300** (300 seconds or 5 minutes) and the **AUSE Cnt** (average count) function set to 12 the display will be averaged and updated every 5 minutes with each new update showing not the average of the last 5 minutes but the average of the last 12 x 5 minute (1 hour) time periods.

For this example starting with a zero display a steady input scaled to read 1200 per hour would read 100 after the first 5 minutes, 200 after the second 5 minutes etc. up to 1200 after 1 hour (12 x 5 minutes). Beyond this time the display will update every 5 minutes showing the average over the last 12 x 5 minute time periods. The rate will be zeroed when the display is switched off of if the input stops for a sufficient time to allow the rate to fall to zero.

7.31 Fast update

Display: **FAST UPdt**
 Range: **on** or **OFF**
 Default Value: **OFF**

Seen only when **SEt OPEr** is set to **FREQ** and **FREQ RNGE** set to **HI F**. With **FAST UPdt** set to **OFF** the relay updates will take place approximately twice per second. With **FAST UPdt** set to on the relay updates will take place approximately six times per second.

7.32 Input edge

Display: **INPt Edge**
 Range: **RISE** or **FALL**
 Default Value: **RISE**

Displays and sets the pulse input edge on which triggering will occur. If set to **RISE** then the rising edge of the input pulse will trigger the input. If set to **FALL** then the falling edge of the input pulse will trigger the input. This function can be useful if one of the edges provides a better switching input than the other e.g. if there is a long rise time in the pulse input but a sharp fall time then select **FALL** as this will give a more definite pulse transition.

7.33 Display rate or period

Display: **dl SP**
 Range: **RAtE** or **PERd**
 Default Value: **RAtE**

Period or rate display - This function is only seen when the **FREQ RNGE** function is set to **LoF**. When using the **LoF** range the user has the option of displaying either the rate of the input or the period of the input. Select **RAtE** for a rate display in Hz. Select **PERd** for a period display (display format is determined by the display range function (**dl SP RNGE**) and the decimal point setting).

7.34 Period display range

Display: **dI SP rNGE**
 Range: **0, 0.0 1, 0.02** or **0.00.02**
 Default Value: **0**

Period display range - Sets the display range when **PER d** is chosen as the default display at the **dI SP** function (**FFe9rNGE** must also be set to **LoF** to see this function).

The **0** option allows a display in seconds. The **0.0 1** option allows a display in minutes and seconds and the **0.00.02** option allows a display in hours.mins.secs

The display units and scaling will now depend on the **PER d dCPt**, **PER d i NPt** and **PER d SCLE** settings e.g. the display can be scaled to give a reading which is ten times the real period if required.

Examples below show how a 2Hz input (0.5 sec or 500mS period) is affected by the **dI SP rNGE**, **PER d dCPt** and **PER d SCLE** functions.

dI SP rNGE	PER d dCPt	PER d i NPt	PER d SCLE	Value displayed
0	0	1	1	500
0	0	1	2	1000
0	0	1	10	5000
0	0.003	1	0.00.0 1	0.500
0.0 1	0.00	1	1.00	500.0
0.00.02	0.00.02	1	0.00.0 1	0.05.00
0.00.02	0.00.02	1	0.0 1.00	0.50.00

With the **PER d i NPt** function set to **1000** the display will time in seconds rather than milli seconds. The display can now be made to show hours minutes and seconds. The table below gives some examples.

dI SP rNGE	PER d dCPt	PER d i NPt	PER d SCLE	Actual Period	Value displayed
0.00.02	0.00.02	1000	0.00.0 1	1m 15sec	0.0 1. 15
0.00.02	0.00.02	1000	0.00.0 1	2h 12m 30sec	2. 12.30

7.35 Rate display time out

Display: **tout SECS**
 Range: **1** or **9999**
 Default Value: **1**

Only seen if **LoF** is selected under the **FFe9rNGE** function. Displays and sets the time out in seconds when using the low frequency (**LoF**) range. The timeout allows very low frequency inputs to be used without the display reverting to zero between samples. If no input pulses are received the display holds the previous display value for the time out period. If a pulse is received during this time the display will update. If no pulses are received or the input period exceeds the time out value set then the display will indicate **0** if displaying rate or **-or-** if displaying period.

7.36 Average display seconds

Display: **AUSE SECS**
Range: **1** or **9999**
Default Value: **1**

Only seen if **AUSE** or **r.AUS** is selected under the **FFE9F9E** function. Displays and sets the number of seconds over which the rate should be averaged when using the low frequency (**LoF**) range. The rate display will not update until the end of the average seconds time. This function allows the user to select a display update rate most suitable for applications in which the rate input may be irregular.

7.37 Remote input function

Display: **r.I NP**
Range: **NONE**, **P.HLd**, **d.HLd**, **H.**, **Lo**, **H. Lo**, **ZEFO**, **SP.Ac**, **No.Ac**, **dI SP**, **dULL** or **g.rSt**
Default Value: **NONE**

When the remote input terminals are short circuited, via a pushbutton or keyswitch the instrument will perform the selected remote input function. A message will flash to indicate which function has been selected when the remote input pins are short circuited. The remote input functions are as follows:

NONE - no remote function required.

P.HLd - peak hold. The display will show the peak hold value whilst the remote input pins are short circuited.

d.HLd - display hold. The display will hold its value whilst the remote input pins are short circuited.

H. - peak memory. The peak value stored in memory will be displayed if the remote input pins are short circuited, if the short circuit is momentary then the display will return to normal measurement after 20 seconds. If the short circuit is held for 1 to 2 seconds then the memory will be cleared.

Lo - valley memory. The minimum value stored in memory will be displayed. Otherwise operates in the same manner as the **H.** function.

H. Lo - toggle between **H.** and **Lo** displays. This function allows the remote input to be used to toggle between peak and valley memory displays. The first operation of the remote input will cause the peak memory value to be displayed, the next operation will give a valley memory display. **PH.** or **PLo** will flash before each display to give an indication of display type. If the short circuit is held for 1 to 2 seconds then the memory will be cleared.

ZEFO - zero the display. The total will be reset when the remote input is short circuited. If the **c.rSt** function is set to **ZEFO** then the display will zero when reset. If the **c.rSt** function is set to **P.SEt** then the display will go to the preset value when reset. This function is not applicable to rate or period displays.

SP.Ac - setpoint access only. This blocks access to any functions except the alarm setpoint functions unless the remote input pins are short circuited or entry is made via **CAL** mode.

No.Ac - no access. This blocks access to all functions unless the remote input pins are short circuited or entry is made via **CAL** mode.

di SP - display toggle. With the **SEt OPEr** function set to both this function will cause the display to toggle from the default display to the alternate display when the remote input pins are short circuited i.e allows toggling between the rate and total display. When the alternate display is being viewed a message will flash every 8 seconds to indicate that the alternate display is being shown e.g. if rate is the alternate display the message **RAtE** will be seen momentarily once every 8 seconds whilst the display is showing rate.

dULL - display brightness control. The remote input can be used to change the display brightness. When this mode is selected the display brightness can be switched, via the remote input, between the brightness level set at the **br9t** function and the brightness level set at the **dULL** function. Not applicable to electromagnetic displays.

g.rSt - grand total reset. This mode allows the remote input to be used as a reset input for the grand total seen in the **tot1** and **both** modes.

7.38 **P** button function

Display: **P.but**
Range: **NONE, H, Lo, H, Lo, ZERO, di SP, FUNC** or **g.rSt**
Default Value: **NONE**

The **P** button may be set to operate one chosen special function. This button is located on the main circuit board. With some functions, to prevent accidental operation, the **P** button must be held pressed for 2-3 seconds before the function will operate. If both the remote input and **P** button function are operated simultaneously the **P** button will override the remote input. The available functions, except for **FUNC**, are as described in the **Fi NP** function above. The **FUNC** function is used only in totalising and can be used to adjust the preset value. When set to **FUNC** the message **P.SEt** will appear when the **P** button is pressed. The operator can then adjust the preset via the **▲** or **▼** button, **F** is then pressed to accept the change. A message **End** will be seen when the new preset value is accepted. When the total is next reset the display will reset to the new preset value if the **c.rSt** function is set to **P.SEt**.

7.39 Access mode

Display: **ACCS**
Range: **OFF, EASY, NONE** or **ALL**
Default Value: **OFF**

Access mode - the access mode function **ACCS** has four possible settings namely **OFF, EASY, NONE** and **ALL**. If set to **OFF** the mode function has no effect on alarm relay operation. If set to **EASY** the “easy alarm access” mode will be activated. Refer to “Easy alarm relay adjustment access facility” section. If set to **NONE** there will be no access to any functions via **FUNC** mode, entry via **CAL** mode must be made to gain access to alarm and calibration functions. If set to **ALL** then access to all functions, including calibration functions, can be gained via **FUNC** mode.

7.40 Setpoint access mode

Display: **SPAC**
Range: **A1, A1-2** etc.
Default Value: **A1**

Setpoint access - seen only if more than 1 relay fitted. Sets the access via **FUNC** mode and “easy alarm access” mode to the alarm relay setpoints. The following choices are available:

A1 - Allows setpoint access to alarm 1 only.

A1-2 - Allows setpoint access to alarms 1 and 2 only.

A1-3 - Allows setpoint access to alarms 1, 2 and 3 etc. up to the maximum number of relays fitted.

The remote input function (**FINP**) must be set to **SPAC** for this function to operate. Note: Only the setpoints which have been given a value will be accessible e.g. if **A1H** is set to **OFF** then there will be no access to the **A1H** function when **SPAC** is used.

7.41 Alarm relay operation mode

Display: **Ax.rE**, **Ax.tL** or **Ax.PS**
Range: **Ax.rE**, **Ax.tL** or **Ax.PS**
Default Value: **Ax.rE**

This function is used to set the operation mode for alarm relays, the “x” indicates relay number e.g. **A1.rE**. Choices available depend on the **SEt OPEr** function setting. With **SEt OPEr** set to **both** mode alarm relays can be set to operate as either a standard setpoint relay operating from rate when **Ax.rE** is selected or total when **Ax.tL** is selected or as a totliser “pass value” relay when **Ax.PS** is selected. In **totL** mode **Ax.tL** or **Ax.PS** may be selected. In **FTE9** mode this function will not appear.

With **Ax.rE** or **Ax.tL** the selected relay will operate from the high and/or low setpoints (**AxH**, and **AxLo**) and values for hysteresis, trip time, reset time, normally open/normally closed operation and setpoint or trailing alarms can also be set. The pass functions **AxPS** and **AxPt** will not be seen if the **Ax.tL** or **Ax.rE** mode is selected. With **Ax.PS** selected relay 1 will operate on a pass value i.e. it will operate on multiples of the **AxPS** value set. The setpoint functions **AxLo**, **AxH**, **AxHY**, **AxtE**, **AxrE**, **AxSP/AxtL** will not be seen if the **AxPS** mode is selected.

7.42 Analog output operation mode

Display: **rEE**
Range: **rAEE** or **totL**
Default Value: **rAEE**

Seen only when the **SEt OPEr** function is set to **both**. Sets the operation mode for the optional analog retransmission. The output can be set to retransmit the total (**totL** or rate (**rAEE**)).

7.43 Second analog output operation mode

Display: **rEEZ**
Range: **rAEE** or **totL**
Default Value: **rAEE**

Seen only when the **SEt OPEr** function is set to **both**. Sets the operation mode for the second optional analog retransmission. The output can be set to retransmit the total (**totL**) or rate (**rAEE**).

7.44 SET terminal input function

Display: **S: NP**
Range: **Lo** or **h, Gh**
Default Value: **h, Gh**

Sets, in conjunction with the SET terminal input, the count up/down operation of the totaliser. The totaliser may be made to count up or count down via this function and if required made to toggle between up and down count mode using an external contact closure between SET and GND terminals. The **S: NP** function and the SET terminal input connection may be used in one of the modes shown in the table below.

S: NP Setting	SET terminal	Operation mode
Lo	Open i.e. no connection to SET terminal	Count down
Lo	Closed i.e. SET terminal shorted to GND terminal	Count up
h, Gh	Open i.e. not connection to SET terminal	Count up
h, Gh	Closed i.e. SET terminal shorted to GND terminal	Count down

7.45 Totaliser counter reset value

Display: **c.rSt**
Range: **ZEZO** or **PSEt**
Default Value: **ZEZO**

The reset terminal operation can be programmed to cause the display to reset to either zero or the selected preset value. Choose either **ZEZO** or **PSEt** to select the required operation. **PSEt** is most commonly selected when the display is required to count down (**S: NP** set to **Lo**) from a preset value.

7.46 Totaliser counter reset signal

Display: **c.rSt**
Range: **Lo, LoE, H,** or **H, E**
Default Value: **Lo**

Allows selection of reset level or edge to force a counter reset. If set to **Lo** a low input level or closed switch on the reset terminal will force a reset, the display will continuously reset whilst the input is low. If set to **H,** a high input level or open switch on the reset terminal will force a reset, the display will continuously reset whilst the reset line is high. If set to **LoE** then a falling edge or

switch closure on the reset terminal will force a reset. If set to **H, E** then a rising edge or switch opening on the reset terminal will force a reset.

7.47 Totaliser counter reset value

Display: **cntr rSt**
Range: Any display value
Default Value: **0**

The counter reset value function allows a number to be set at which the display will automatically reset. The automatic counter reset function can be disabled by setting the function to **0**. This function is only applicable to upward counting applications i.e. the total is increasing. For example if **cntr rSt** is set to **100** and **c.rSt** is set to **2EFD** then when the display value reaches **99** the next input pulse will cause the instrument to automatically reset to **0**. If the **cntr rSt** function is set to **0** then the display will not automatically reset and when the count has gone below the display limit the overrange warning message **-or-** will be seen. The only way to clear the overrange message is to reset the display.

7.48 Alarm 1 high reset

Display: **A 1H, rSt**
Range: **on** or **OFF**
Default Value: **OFF**

Applies to relay 1 only. The alarm 1 high reset function allows the alarm operation to also cause an automatic total display reset. If the alarm mode is set to total (**A 1tL**) then when the display value reaches the value set at **A 1H,** the relay will operate momentarily (the duration of the relay pulse can be extended via the **A 1rL** function if required). If the alarm mode is set to pass (**A 1PS**) then the display will reset when the display value reaches the pass value (set at **A 1PS**) and the relay will activate and will remain activated for the time set at the **A 1Pt** function.

7.49 Default display

Display: **df1 t di SP**
Range: **rAtE, PEFD** or **tot1**
Default Value: **rAtE**

Seen only in **both** mode. Sets the display default to either total or rate (or period if **di SP** is set to **PEFD**). The display will always revert to the default display on power up but can be forced to the alternate display via the **P** button or remote input (see **P.but** and **r.i NP** functions). If the alternate display is being viewed an identifier will flash briefly every 8 seconds approx. e.g. if the rate is the default display and the display is now toggled to show total the message **tot1** will flash briefly every 8 seconds.

7.50 Set display operation

Display: **SEt OPEr**
Range: **S.Prd, PErd, FFE9, totL** or **both**
Default Value: **FFE9**

Displays and sets the selected operating mode, e.g. select **totL** for totaliser operation. Options are:

S.Prd - Not applicable to this instruction manual

PErd - Not applicable to this instruction manual

both - Frequency and total - allows toggling between rate and total display

totL - Total/counter display

FFE9 - Frequency/rate display

7.51 Baud rate for optional serial communications

Display: **BAUd RATE**
Range: **300.600.1200.2400.4800.9600.19.2** or **38.4**
Default Value: **9600**

Set baud rate - seen only with serial output option. Refer to the separate "RM4 Din Rail Meter Optional Output Addendum" booklet supplied when optional outputs are fitted. Select from **300.600.1200.2400.4800.9600.19.2** or **38.4** baud. The baud rate should be set to match the device being communicated with.

7.52 Parity for optional serial communications

Display: **Prty**
Range: **NONE.EVEN** or **odd**
Default Value: **NONE**

Set parity - seen only with serial output option. Refer to the separate "RM4 Din Rail Meter Optional Output Addendum" booklet supplied when optional outputs are fitted. Select parity check to either **NONE**, **EVEN** or **odd**. The parity should be set to match the device being communicated with.

7.53 Output mode for optional serial communications

Display: **O.PUt**
Range: **d, SP.Cont.POLL, R.buS** or **~.buS**
Default Value: **Cont**

Set serial interface mode - seen only with serial output option. Refer to the separate "RM4 Din Rail Meter Optional Output Addendum" booklet supplied when optional outputs are fitted. Allows user to select the serial interface operation as follows:

d, SP - sends image data from the display without conversion to ASCII.

Cont - sends 8 bit ASCII form of display data at a rate typically 90% of the sample rate.

POLL - controlled by computer or PLC as host. Host sends command via RS232/485 and instrument responds as requested.

A.buS - is a special communications mode used with Windows compatible optional PC download software. Refer to the user manual supplied with this optional software.

ā.buS - Modbus RTU protocol.

7.54 Instrument address for optional serial communications

Display: **Addr**
Range: **0 to 31**
Default Value: **0**

Set unit address for polled (**POLL**) or **ā.buS** mode (**0 to 31**) - seen only with serial output option. Refer to the separate "RM4 Din Rail Meter Optional Output Addendum" booklet supplied when optional outputs are fitted. Allows several units to operate on the same RS485 interface reporting on different areas etc. if RS485 is available. The host computer or PLC may poll each unit in turn supplying the appropriate address. The unit address ranges from 0 to 31 (DEC) but is offset by 32 (DEC) to avoid clashing with ASCII special function characters (such as <STX> and <CR>). Therefore 32 (DEC) or 20 (HEX) is address 0, 42 (DEC) or 2A (HEX) is address 10. Do not use address 0 in **ā.buS** mode.

8 Specifications

8.1 Technical specifications

Input:	Link selectable internal pull up resistor, internal pull down resistor, biased input, DC couple and 2V added hysteresis. For inductive, AC and square wave inputs the maximum input voltage is 48VDC or RMS with appropriate link settings.
Totaliser functions:	Scaleable up or down counter. Total and grand total memory.
Ratemeter functions:	Scaleable rate (or period for frequencies <1kHz) display.
Accuracy:	For frequency or period measurement 0.01% , $\pm 10\mu\text{s}$.
Impedance:	10K Ω
Max count rate:	100kHz
Microprocessor:	HC68HC11F CMOS
Ambient temperature:	-10 to 60° C
Humidity:	5 to 95% non condensing
Display:	LED 5 digit 7.6mm + alarm annunciator LEDs
Power supply:	AC 240V, 110V 32V or 24V 50/60Hz or DC isolated wide range 12 to 48V. Note: supply type is factory configured.
Power consumption:	AC supply 4 VA max, DC supply typically 100mA at 12VDC and 50mA at 24VDC for RM4 with no optional outputs.
Output (standard):	2 x relay, Form A, rated 5A resistive. Programmable N.O. or N.C

8.2 Optional outputs

Third relay:	Rated 0.5A resistive 30VAC or DC May be configured as form A or form C if the third relay is the only option fitted
Fourth relay:	Rated 0.5A resistive 30VAC or DC, form A
Analog output:	Isolated 4 to 20mA, 0 to 1V or 0 to 10V link selectable 12 or 16 bit versions available (4-20mA will drive into resistive loads of up to 800 Ω) First analog output can be configured for retransmission or PI control.
Serial communications:	Isolated RS232, RS485 or RS422 (8 bit ASCII or Modbus RTU)
DC supply output:	Isolated and regulated 12VDC (50mA max) or 24VDC (25mA max)

Some combinations of optional outputs are available e.g. analog output plus extra relay. Consult supplier for available combinations.

8.3 Physical characteristics

Case size:	44mm(w) x 91mm(h) x 141mm(d)
Connections:	Plug in screw terminals (max. 2.5mm ² wire for power and relays, max. 1.5mm ² wire for load cell and options)
Weight:	470 gms basic model, 500 gms with option card

9 Guarantee and service

The product supplied with this manual is guaranteed against faulty workmanship for a period of two years from the date of dispatch.

Our obligation assumed under this guarantee is limited to the replacement of parts which, by our examination, are proved to be defective and have not been misused, carelessly handled, defaced or damaged due to incorrect installation. This guarantee is VOID where the unit has been opened, tampered with or if repairs have been made or attempted by anyone except an authorised representative of the manufacturing company.

Products for attention under guarantee (unless otherwise agreed) must be returned to the manufacturer freight paid and, if accepted for free repair, will be returned to the customers address in Australia free of charge.

When returning the product for service or repair a full description of the fault and the mode of operation used when the product failed must be given. In any event the manufacturer has no other obligation or liability beyond replacement or repair of this product.

Modifications may be made to any existing or future models of the unit as it may deem necessary without incurring any obligation to incorporate such modifications in units previously sold or to which this guarantee may relate.

This document is the property of the instrument manufacturer and may not be reproduced in whole or part without the written consent of the manufacturer.

This product is designed and manufactured in Australia.