

**Model PM5-TMR
Timer
Panel Mount Display/Controller
Operation and Instruction Manual**

AMALGAMATED INSTRUMENT CO

*Unit 5, 28 Leighton Place Hornsby
NSW 2077 Australia*

*Telephone: +61 2 9476 2244
Facsimile: +61 2 9476 2902*

*ABN: 80 619 963 692
e-mail: sales@aicpl.com.au
Internet: www.aicpl.com.au*

Table of Contents

1	Introduction	3
2	Mechanical Installation	8
3	Electrical installation	9
4	Function tables - summary of setup functions	17
5	Explanation of functions	24
6	Specifications	48
7	Guarantee and service	49

1 Introduction

General description

This manual contains information for the installation and operation of the PM5-TMR display. The display has several modes of operation allowing up timing, down timing, stopwatch operation etc. The mode required can be set at the **CONF OPER** function. Timer display units e.g. minutes and seconds and decimal points are also user configurable.

1.1 Selecting and altering access levels

This subsection details the use "access levels". Access levels can be used to obtain easy access to functions which are regularly required and to limit access to functions which are not required or which restricted access is required. These access level settings can be ignored if no restrictions to access are required and no easy access to selected functions is required.

Each setup function has a default access level allocated to it, for example the relay 1 high alarm function **AL 1h, 9h** is allocated a default level of 2. There is a facility for the user to change the access levels for a limited number of functions to make them either easier to access or harder to access as required, see the **Fn. iCode** function.

There are different ways of accessing setup functions, these are explained in the following section. Each mode allows a selection of access levels i.e. allows some choice of which functions are accessible.

The access levels available are:

None - no access to functions

1 - access to functions allocated to level 1

2 - access to functions allocated to level 2

3 - access to functions allocated to level 3

4 - access to functions allocated to level 4

5 - access to functions allocated to level 5

6 - access to functions allocated to level 6

CAL - access to all normal operation functions

1.2 Accessing setup functions

The setup functions allow adjustment of the instruments operation functions. There are five different ways of accessing setup functions. Each mode allows a selection of access levels i.e. allows some choice of which functions are accessible.

As a summary the methods available are:

- **Easy mode** - this is the easiest access mode simply requiring the **F** button to be pressed for 3 seconds. This mode would normally be used to gain access to functions which require frequent adjustment.
- **Remote input mode** - this uses the Easy method of access but also requires the use of a remote input switch.
- **PIN 1 mode** - this method allows a PIN to be set with access via PIN entry.

- **PIN 2 mode** - this method also requires a PIN and would generally be use to allow a higher access level than the first PIN.
- **Super Cal mode** - this method requires a power up procedure and will allow access to all functions.

These modes are explained in more detail below.

- **Easy mode** - Allows access to the level set by the **EASY LEVEL** function in the **ACCS** menu. By default the Easy access is set to **NONE** which blocks access to all setup functions. To allow access to functions using this method choose the access level required at the **EASY LEVEL** function.

The Easy mode simply requires that the **F** button is held pressed until the message **FUNC** is seen followed by the first function message, this should take approximately 3 seconds. If the message **FUNC End** or no response is seen at this point it means that the access level has been set to **NONE**. The default access for this level is **NONE** so the access level will need to be changed if access via this method is required.

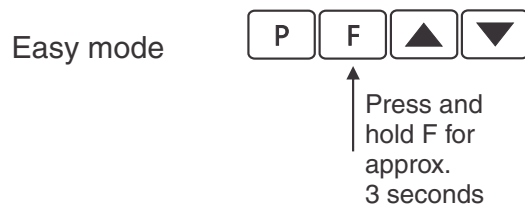

- **Remote input mode** - Allows access to the level set by the **REMOTE LEVEL** function in the **ACCS** menu. By default the Remote input access is set to **CAL** level allowing access to all setup functions.

The remote input mode uses the same access method as the Easy mode but also requires that one of the available remote inputs is set to **ACCESS** and that the selected remote input is activated i.e. shorted to GND. The default access for this level is **NONE** so the access level will need to be changed if access via this method is required.

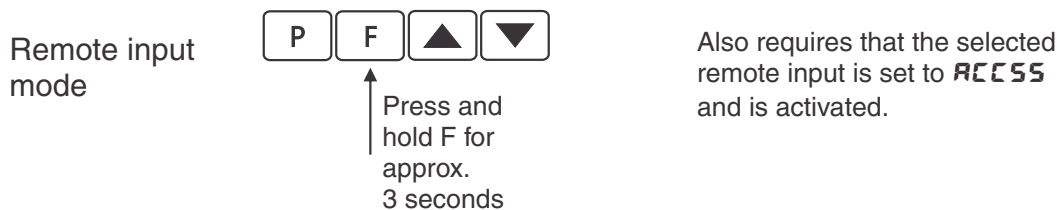

- **PIN 1 mode** - Allows access to the level set by the **USF. 1 LEVEL** function in the **ACCS** menu.

The PIN 1 mode requires the **F** button is pressed and released then within 2 seconds press the **▲** and **▼** buttons at the same time. The PIN can be set via the **USF. 1 P, n** function in the **ACCS** menu. A **USF. 1 LEVEL** setting of **0** disables the PIN which means that there is no need to enter the PIN. If the **USF. 1 LEVEL** function has been set to a number other than **NONE** then the first function seen when entering via PIN 1 mode will be the function **Code**. When this function is seen the PIN value set at the **USF. 1 P, n** function must be entered via the **▲** or **▼** pushbuttons followed by pressing **F** to accept the PIN before the user can progress to the setup functions.

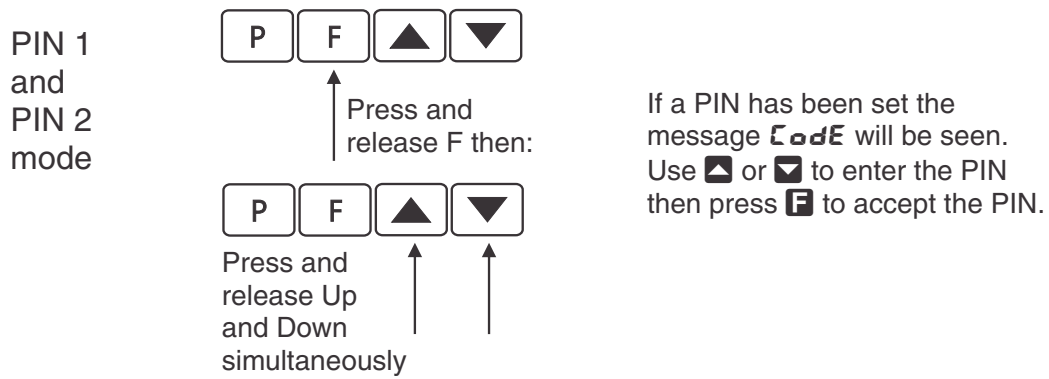

- **PIN 2 mode** - Allows access to the level set by the **USF.2 LEVL** function in the **ACCS** menu.

This method uses the same access method as PIN 1 mode above. A **USF.2 P, n** setting of **0** disables the PIN. If the **USF.1 LEVL** or a **USF.2 P, n** function has been set to a number other than **0** then the first function seen when entering via PIN 1/PIN2 mode will be the function **CODE**. When this function is seen the PIN value set at the **USF.1 P, n** function can be entered for access to the level set at the **USF.1 LEVL** function or enter the **USF.2 P, n** PIN to gain access to the level set at the **USF.2 LEVL** function. A correct code will allow access to the functions at the selected level. An incorrect code will result in the **FUNC End** message being seen indicating that access to setup functions has been refused and the display will return to normal measurement mode.

- **Super Cal mode** - This method can be used to gain access to all functions. If a PIN has been set and forgotten use this method to access the PIN functions to check the settings. To access via Super Cal mode with the instrument switched off hold in the **F** button whilst the instrument powers up. Keep the button pressed until the **S.CAL** message is seen, you can then release the **F** button. Next press and release **F** then within 2 seconds press and release the **▲** and **▼** pushbuttons simultaneously.

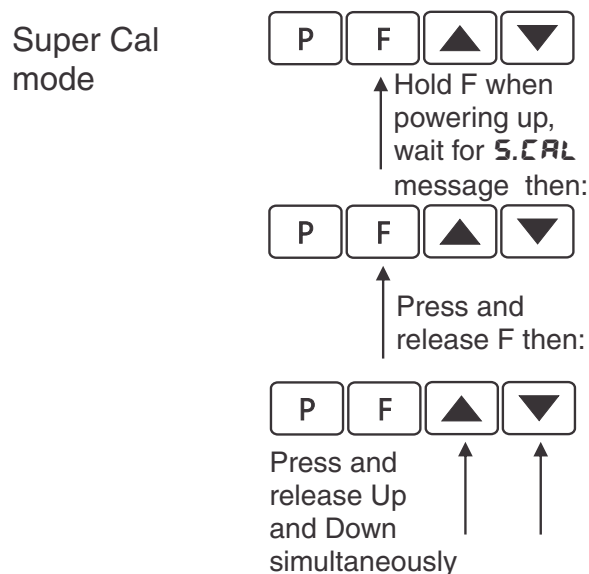

The setup functions are organised in blocks or sections e.g. all the settings for channel 1 alarms are in the **AL 1** section. Once access to setup functions has been gained use the **▲** and **▼** buttons to select the section required then press **F** to enter this section and again use the **▲** and **▼** buttons to select the required function for alteration and press **F** to allow alteration of this function.

Typical sections for a basic instrument are illustrated below. In any particular instrument additional sections may appear depending on the part number and any optional outputs fitted.

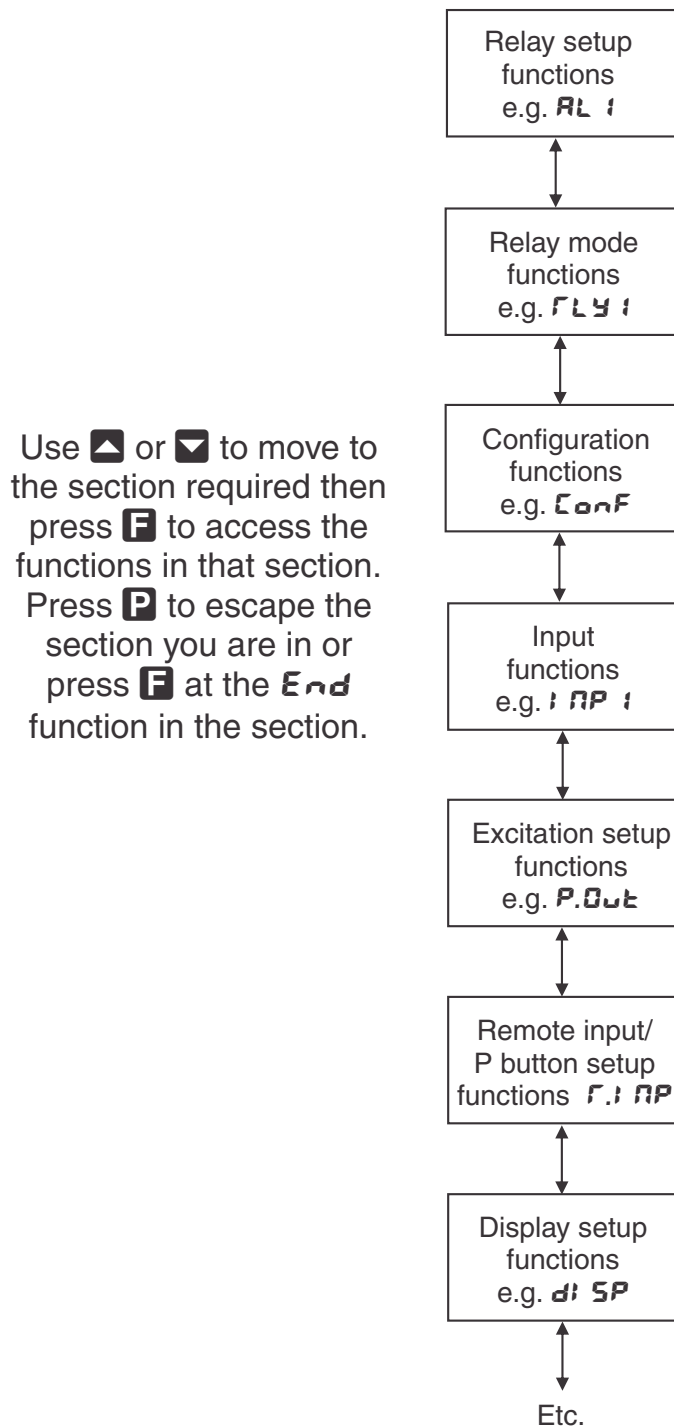

The example in the flowchart (for 4 digit display) below shows the method using alarm relay 1 setup function.

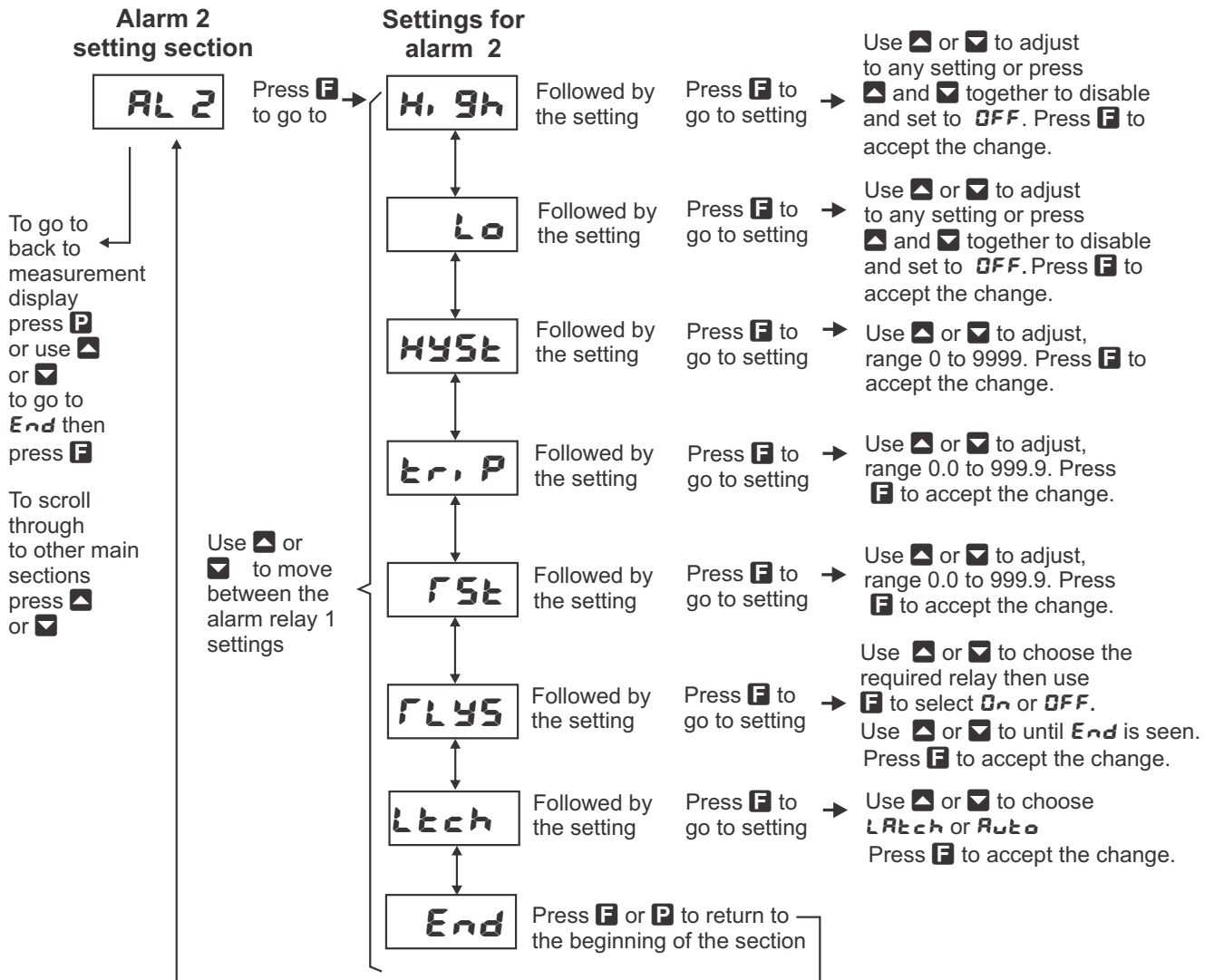

2 Mechanical Installation

Choose a mounting position as far away as possible from sources of electrical noise such as motors, generators, fluorescent lights, high voltage cables/bus bars etc. An IP67 access cover which may be installed on the panel and surrounds is available as an option to be used when mounting the instrument in damp/dusty positions. A wall mount case is available, as an option, for situations in which panel mounting is either not available or not appropriate. A portable carry case is also available, as an option, for panel mount instruments.

Prepare a panel cut out of 45mm x 92mm +1 mm / - 0 mm (see diagram below). Insert the instrument into the cut out from the front of the panel. From the rear of the instrument fit the two mounting brackets into the recess provided (see diagram below). Whilst holding the bracket in place, tighten the securing screws being careful not to over-tighten, as this may damage the instrument. Hint: use the elastic band provided to hold the mounting bracket in place whilst tightening securing screws.

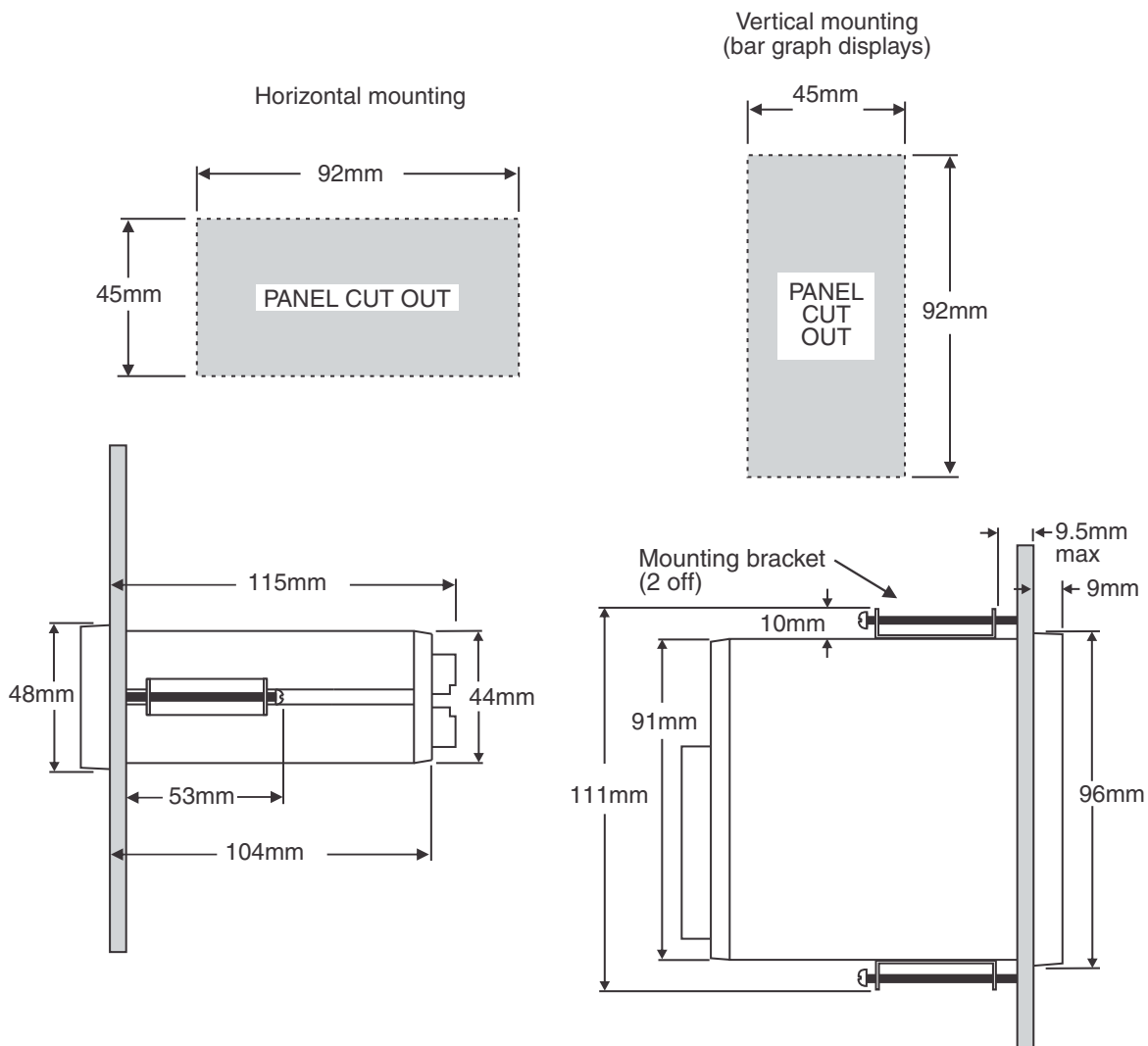

3.2 Input connections

The display will accept many common input sensor types on inputs 1 and 2. The input ground for all signal inputs is on terminal 10. Input 1 (terminal 9) is used as the main input terminal initiating the start of the timing process. Input 2 (terminal 8) can be used as the reset or preset input in all operation modes except **UP** and **dn** modes. In **UP** and **dn** modes input 2 is used as the stop input and a remote input must be allocated for use as the reset or preset input. The input circuit setups for input 1 (terminals 9 and 10) shown below are software configured via the **I N 1** or **I NP 1** functions e.g. **I N 1 PULL UP**. The input circuit setups for input 2 (terminals 8 and 10) are software configured via the **I N 2** or **I NP 2** functions. Remote inputs require a voltage free switch or 5V to 0V switching voltage.

Connections for each operation mode

Various timer operation modes are available, see the **CONF OPER** function. The diagrams below show the required connections for each mode. In the **UP** and **dn** example remote input 1 is shown as the reset/preset input but remote input 2 could alternatively be used.

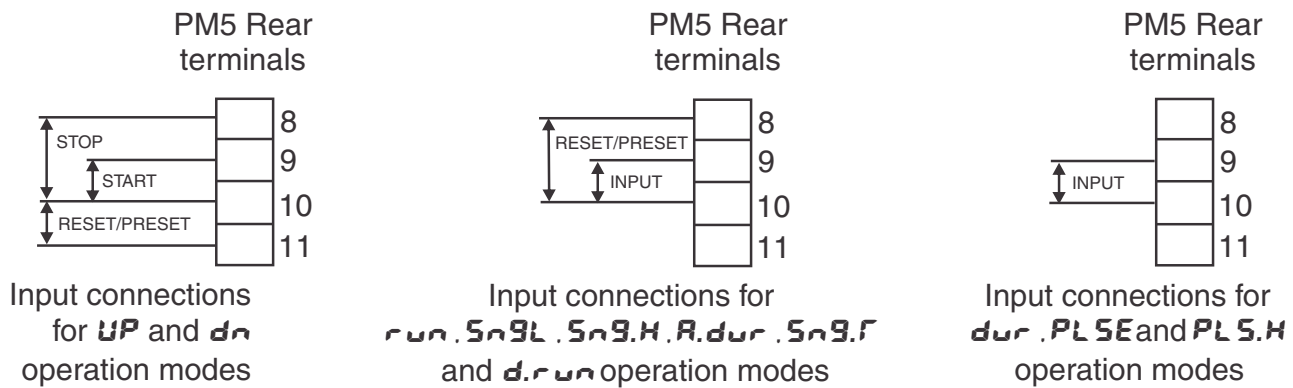

Sensor type settings and connections - examples show input 1 wiring

Inductive sensor input

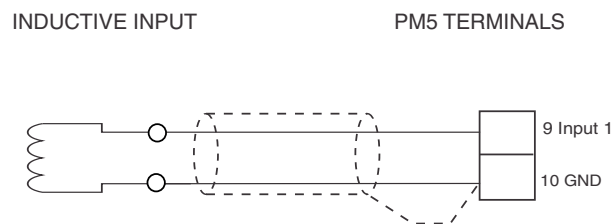

I N 1 function settings settings for inductive input

- **PULL UP** Set to **Lo**
- **b1 AS** Set to **OFF**
- **LoF** Set to **OFF**
- **HYSL** Set to **OFF** for very low amplitude inputs (25mV to 250mV) or **On** for inputs with amplitude 250mV to 48VDC or RMS

- **Att_n** Set to **OFF** for no attenuation or **On** to reduce the input amplitude by a factor of 5
- **dC** Set to **On**
- **EDGE** Select **Lo** (trigger from low going edge) or **H_i** (trigger from rising edge) as required
- **d.bnc** Normally only required for contact closure e.g. relay or switch input. Select a debounce time which allows operation without false triggering due to contact bounce

AC input

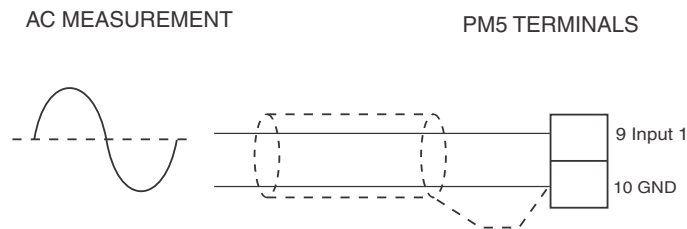

! !! function settings settings for AC input

- **PULL UP** Set to **Lo**
- **bIAS** Set to **OFF**
- **LoF** Set to **OFF**
- **HYS_t** Set to **OFF** for very low amplitude inputs (25mV to 250mV) or **On** for inputs with amplitude 250mV to 48VDC or RMS
- **Att_n** Set to **OFF** for no attenuation or **On** to reduce the input amplitude by a factor of 5
- **dC** Set to **On** for input frequencies less than 10 Hz, otherwise set to **OFF**
- **EDGE** Select **Lo** (trigger from low going edge) or **H_i** (trigger from rising edge) as required
- **d.bnc** Normally only required for contact closure e.g. relay or switch input. Select a debounce time which allows operation without false triggering due to contact bounce

Square wave input

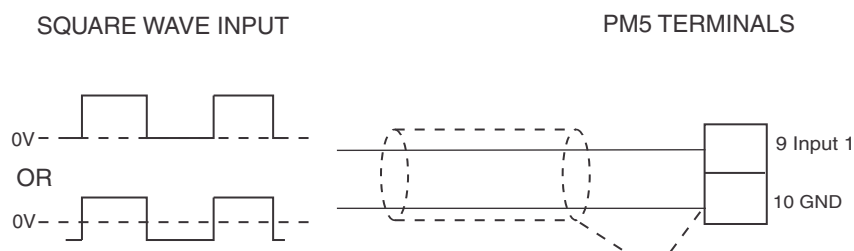

! !! function settings for square wave input

- **PULL UP** Set to **Lo**
 - **bIAS** Set to **On** if signal is never negative polarity, otherwise set to **OFF**
 - **LoF** Set to **OFF**
 - **HYSL** Set to **OFF** for very low amplitude inputs (25mV to 250mV) or **On** for inputs with amplitude 250mV to 48VDC or RMS
 - **AttN** Set to **OFF** for no attenuation or **On** to reduce the input amplitude by a factor of 5
 - **dC** Set to **On**
 - **EDGE** Select **Lo** (trigger from low going edge) or **Hi** (trigger from rising edge) as required
 - **d.bnc** Normally only required for contact closure e.g. relay or switch input. Select a debounce time which allows operation without false triggering due to contact bounce
-

Contact closure input

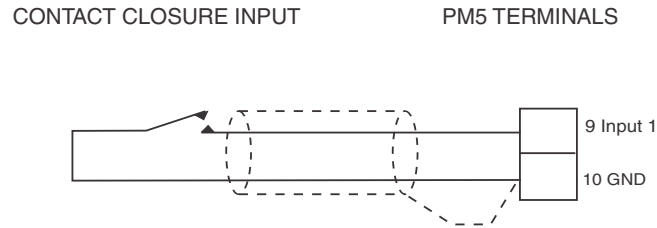

! n ! function settings for contact closure input

- **PULL UP** Set to **H, 9h**
- **bi AS** Set to **0n**
- **LoF** Set to **0n**
- **HYS** Set to **0n**
- **Att** Set to **OFF** for no attenuation or **0n** to reduce the input amplitude by a factor of 5
- **dC** Set to **0n**
- **EDGE** Select **Lo** (trigger from low going edge) or **H** (trigger from rising edge) as required
- **d.bnc** Normally only required for contact closure e.g. relay or switch input. Select a debounce time which allows operation without false triggering due to contact bounce

Namur sensor input

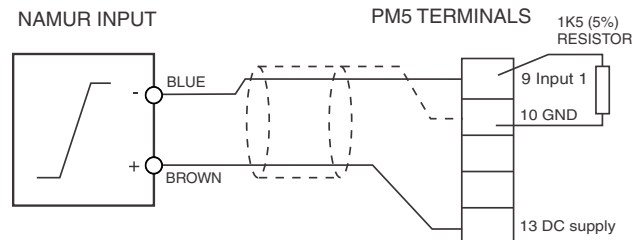

! n ! function settings for namur sensor input

- **PULL UP** Set to **Lo**
- **bi AS** Set to **0n**
- **LoF** Set to **OFF**
- **HYS** Set to **0n**
- **Att** Set to **OFF** for no attenuation or **0n** to reduce the input amplitude by a factor of 5
- **dC** Set to **0n**
- **EDGE** Select **Lo** (trigger from low going edge) or **H** (trigger from rising edge) as required
- **d.bnc** Normally only required for contact closure e.g. relay or switch input. Select a debounce time which allows operation without false triggering due to contact bounce

NPN 2 wire sensor input

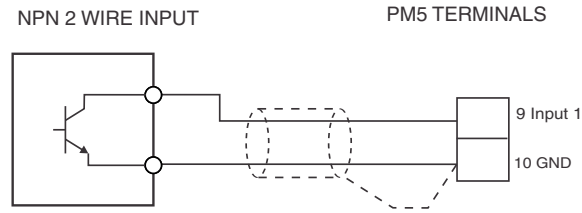

PM5 function settings for NPN 2 wire sensor input

- **PULL UP** Set to **H, 9h**
- **bIAS** Set to **0n**
- **LoF** Set to **OFF**
- **HYSk** Set to **0n**
- **AttN** Set to **OFF** for no attenuation or **0n** to reduce the input amplitude by a factor of 5
- **dC** Set to **0n**
- **EDGE** Select **Lo** (trigger from low going edge) or **H,** (trigger from rising edge) as required
- **d.bnc** Normally only required for contact closure e.g. relay or switch input. Select a debounce time which allows operation without false triggering due to contact bounce

NPN 3 wire sensor input

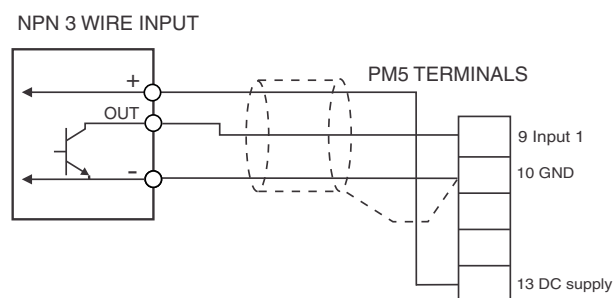

PM5 function settings for NPN 3 wire sensor input

- **PULL UP** Set to **H, 9h**
- **bIAS** Set to **0n**
- **LoF** Set to **OFF**
- **HYSk** Set to **0n**
- **AttN** Set to **OFF** for no attenuation or **0n** to reduce the input amplitude by a factor of 5

- **dc** Set to **On**
- **EDGE** Select **Lo** (trigger from low going edge) or **Hi** (trigger from rising edge) as required
- **d.bnc** Normally only required for contact closure e.g. relay or switch input. Select a debounce time which allows operation without false triggering due to contact bounce

PNP 2 wire sensor input

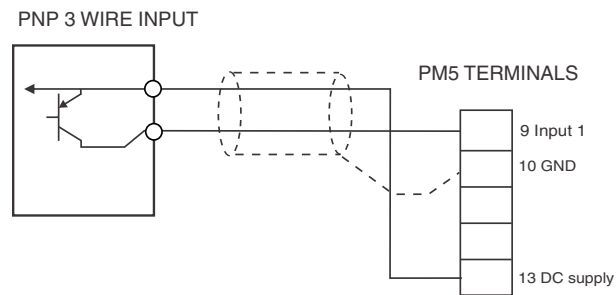

! n ! function settings for PNP 2 wire sensor input

- **PULL UP** Set to **Lo**
- **bi AS** Set to **On**
- **LoF** Set to **OFF**
- **HYS** Set to **On**
- **Att** Set to **OFF** for no attenuation or **On** to reduce the input amplitude by a factor of 5
- **dc** Set to **On**
- **EDGE** Select **Lo** (trigger from low going edge) or **Hi** (trigger from rising edge) as required
- **d.bnc** Normally only required for contact closure e.g. relay or switch input. Select a debounce time which allows operation without false triggering due to contact bounce

PNP 3 wire sensor input

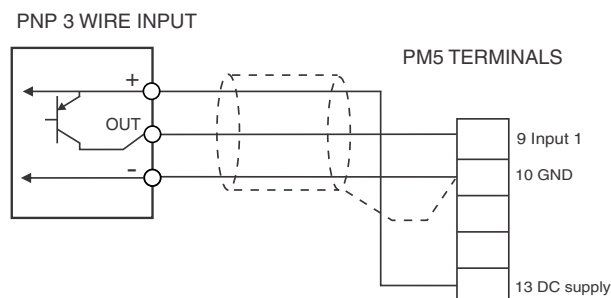

! n ! function settings for PNP 3 wire sensor input

- **PULL UP** Set to **Lo**
 - **BIAS** Set to **On**
 - **LoF** Set to **OFF**
 - **HYS** Set to **On**
 - **Att** Set to **OFF** for no attenuation or **On** to reduce the input amplitude by a factor of 5
 - **dc** Set to **On**
 - **EDGE** Select **Lo** (trigger from low going edge) or **H** (trigger from rising edge) as required
 - **dbnc** Normally only required for contact closure e.g. relay or switch input. Select a debounce time which allows operation without false triggering due to contact bounce
-

3.3 Relay connections

Relay connections The PM5 is supplied with one alarm relay as standard with connections on terminals 4 and 5, extra relays are optionally available. The relay is a single pole, single throw type and is rated at 5A, 240VAC into a resistive load. The relay contact is voltage free and may be programmed for normally open or normally closed operation.

3.4 Remote input connections

Two programmable remote input connections are available. The function of the remote input can be set for software. To operate the remote input connect a voltage free switch or relay (momentary or latching depending on the operation selected) between the remote input terminal and ground. The relay contacts will open when power is removed.

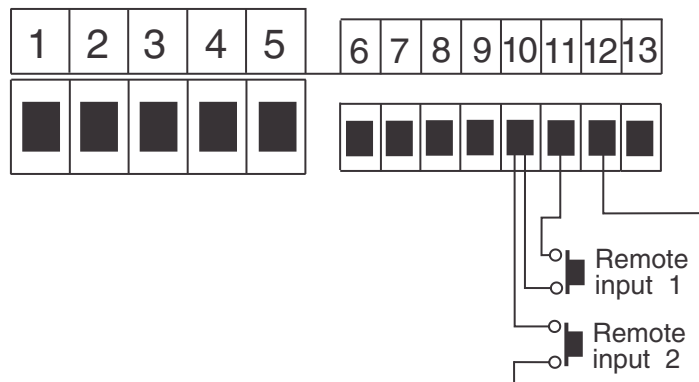

3.5 DC Sensor supply

The DC sensor supply on terminal 13 can be configured for 5V or 18VDC (25mA max.) via the **P.Out** function.

4 Function tables - summary of setup functions

Note: the order in which the functions appear on the display may not be exactly as shown below. The availability and order of functions is determined by choice of function settings and options fitted.

Display messages shown are those which would appear on a 5 digit display, these display messages may in some cases vary slightly for other display types.

Any functions which rely on options being fitted will be denoted by an asterisk *.

Some of the functions shown in the table below require access via Super Cal **S.CAL** mode.

4.1 Alarm relay function table

Display	Function	Range	Default	Your record	Ref/Page
AL 1 to AL B Hi, 9h	High setpoint value for designated alarm	Any display value or OFF	OFF	See 4.14	5.1 / 24
AL 1 to AL B Lo	Low setpoint value for designated alarm	Any display value or OFF	OFF	See 4.14	5.2 / 25
AL 1 to AL B HYST	Hysteresis value for the designated alarm	0 to 50000	10	See 4.14	5.3 / 26
AL 1 to AL B TRIP	Trip time delay for the designated alarm relay <i>x</i> .	0 to 5000.0 secs	0.0	See 4.14	5.4 / 26
AL 1 to AL B RST	Reset time delay for the designated alarm relay <i>x</i> .	0 to 5000.0 secs	0.0	See 4.14	5.5 / 27
AL 1 to AL B FLYS	Relay selection ON or OFF	ON or OFF	OFF	See 4.14	5.6 / 27
AL 1 to AL B LATCH	Alarm relay latching operation	Auto, Latch	Auto	See 4.14	5.7 / 27

4.2 Relay function table

Display	Function	Range	Default	Your record	Ref/Page
FL 1 to FL 7 FLY	Alarm relay <i>x</i> action to normally open (de-energised) or normally closed (energised)	n.o, n.c	n.o	See 4.14	5.8 / 28
FL 1 to FL 7 ACK	Relay acknowledge	OFF or ON	OFF	See 4.14	5.9 / 28

FL 1 to FL 7 bool	Alarm relay Boolean logic operation	Or, And	Or	See 4.14	5.10 / 28
----------------------------------	-------------------------------------	----------------	-----------	----------	-----------

4.3 Analog output function table

Display	Function	Range	Default	Your record	Ref/Page
FO 1 OutP	Output selection for analog output 1. Not seen if output is fixed at 4-20mA (*Optional)	4-20.0-10.0-10	4-20		5.11 / 29
FO 1 Lo	Analog output 1 option low display value (*Optional)	Any display value	0		5.12 / 29
FO 1 Hi, 9h	Analog output option high display value (*Optional)	Any display value	1000		5.13 / 29

4.4 Analog output 2 function table

Display	Function	Range	Default	Your record	Ref/Page
FO 2 OutP	Output selection for analog output 2. Not seen if output is fixed at 4-20mA (*Optional)	4-20, 0-10 or 0-10	4-20		5.14 / 30
FO 2 Lo	Analog output 2 option low display value (*Optional)	Any display value	0		5.15 / 30
FO 2 Hi, 9h	Analog output option high display value (*Optional)	Any display value	1000		5.16 / 30

4.5 Timer configuration function table

Display	Function	Range	Default	Your record	Ref/Page
CONF OPER	Operating mode	run, dur, PLSE, SngL, PLS.H, Sng.H, UP, dn, d.run	run		5.17 / 31
CONF RNGE	Time display range	SECS, nn.SS, h.nn.S, nnn, hh.nn, hrS, dd.hh, dAYS	SECS		5.18 / 33
CONF d.Pnt	Decimal point	0, 0.1, 0.02, 0.003	0		5.19 / 33
CONF P.SET	Preset	Any display value	0		5.20 / 34
CONF R.SET	Reset mode	RSt, P.SET	RSt		5.21 / 34

CONF STOP ZERO	Stop at zero	OFF or ON	OFF		5.22 / 35
CONF RUN FLASH	Display running indication	OFF or ON	ON		5.23 / 35
CONF P.ON FSt	Reset at power up	OFF , F.SET , P.SET	OFF		5.24 / 35

4.6 Bargraph function tables - for bargraph display models only

Display	Function	Range	Default	Your record	Ref/Page
bARg TYPE	Bargraph type	bAR , S.dot , d.dot or L.bAR	bAR		5.25 / 36
bARg Lo	Bargraph low value	Any display value	0		5.26 / 36
bARg Hi	Bargraph high value	Any display value	1000		5.27 / 36

4.7 Input function tables

Display	Function	Range	Default	Your record	Ref/Page
IN2 OPER	Input 2 operation mode	None , FSt , P.SET	None		5.28 / 37
IN1 to IN2 PULL UP	Input pull up	OPER , Hi , 9h , Lo	Hi , 9h		5.29 / 37
IN1 to IN2 BIAS	Input bias	OFF , ON	ON		5.30 / 37
IN1 to IN2 LoF	Input low frequency	OFF , ON	OFF		5.31 / 38
IN1 to IN2 HYS	Input hysteresis	OFF , ON	OFF		5.32 / 38
IN1 to IN2 Att	Input attenuation	OFF , ON	OFF		5.33 / 38
IN1 to IN2 dC	Input DC coupling	OFF , ON	ON		5.34 / 39

I.N1 to I.N2 Edge	Input edge or level	Lo, Hi	Lo		5.35 / 39
I.N1 to I.N2 d.bnc	Input de-bounce timer	0 to 1000 ms	0		5.36 / 39

4.8 Excitation voltage function tables

Display	Function	Range	Default	Your record	Ref/Page
P.Out P.Out	Output voltage selection	5V, 12 or 18V	5V		5.37 / 40

4.9 P button and remote inputs function table

Display	Function	Range	Default	Your record	Ref/Page
F.I.NP P.but	Front P button operation mode	NONE, P.Hi, P.Lo, Hi, .Lo, AL.Ac, FSEt, PSEt	NONE		5.38 / 40
F.I.NP F.I.N.1 to F.I.N.2	Remote input 1 operation mode	NONE, P.Hi d, d.Hi d, P.Hi, P.Lo, Hi, .Lo, AL.Ac, ACCS, dui1, FSEt, PSEt	NONE		5.39 / 40
F.I.NP F.I.N.2	Remote input 2 operation mode	NONE, P.Hi d, d.Hi d, P.Hi, P.Lo, Hi, .Lo, AL.Ac, ACCS, dui1, FSEt, PSEt	NONE		5.40 / 41

4.10 Display function table

Display	Function	Range	Default	Your record	Ref/Page
d.SP br9t	Display brightness	1 to 16	16		5.41 / 41
d.SP dui1	Dimmed display brightness	0 to 16	2		5.42 / 42

4.11 Serial communications functions

Display	Function	Range	Default	Your record	Ref/Page
SErI OPER	Serial operation mode (*Optional)	None, Cont. Poll, R.buS, di SP or n.buS	None		5.43 / 42
SErI bAud	Serial baud rate (*Optional)	1200, 2400, 4800, 9600, 19.2, 38.4, 57.6, 115.2	9600		5.44 / 42
SErI Prty	Serial parity (*Optional)	8N, 8E, 8O, 7 E, 7O	8N		5.45 / 43
SErI Unit Addr	Serial address (*Optional)	1 to 127	1		5.46 / 43

4.12 Alarm configuration function table

Display	Function	Range	Default	Your record	Ref/Page
ALCF ALCnt	Select number of alarms	0, 1, 2, 3, 4, 5, 6, 7, 8	2		5.47 / 43

4.13 Access control function table

Display	Function	Range	Default	Your record	Ref/Page
ACCES EASY LEVL	Easy access mode	None, 1, 2, 3, 4, 5, 6, CAL	None		5.48 / 43
ACCES FANP LEVL	Remote input access mode	None, 1, 2, 3, 4, 5, 6, CAL	None		5.49 / 44
ACCES USF.1 PIN	PIN code 1	0 to 50000	0		5.50 / 44
ACCES USF.1 LEVL	PIN code 1 access level	None, 1, 2, 3, 4, 5, 6, CAL	None		5.51 / 44
ACCES USF.2 PIN	PIN code 2	0 to 50000	0		5.52 / 45
ACCES USF.2 LEVL	PIN code 2 access level	None, 1, 2, 3, 4, 5, 6, CAL	None		5.53 / 45

ACCES Fn.1 Code	User assignable access function 1	0000 to FFFF hex.	0000		5.54 / 45
ACCES Fn.1 LEVL	User assignable access 1 level value	dF1 t, 1, 2, 3, 4, 5, 6, CAL, S.CAL	dF1 t		5.55 / 46
ACCES Fn.2 Code	User assignable access function 2	0000 to FFFF hex.	0000		5.56 / 46
ACCES Fn.2 LEVL	User assignable access 2 level value	dF1 t, 1, 2, 3, 4, 5, 6, CAL, S.CAL	dF1 t		5.57 / 46
ACCES Fn.3 Code	User assignable access function 3	0000 to FFFF hex.	0000		5.58 / 46
ACCES Fn.3 LEVL	User assignable access 3 level value	dF1 t, 1, 2, 3, 4, 5, 6, CAL, S.CAL	dF1 t		5.59 / 47
ACCES Fn.4 Code	User assignable access function 4	0000 to FFFF hex.	0000		5.60 / 47
ACCES Fn.4 LEVL	User assignable access 4 level value	dF1 t, 1, 2, 3, 4, 5, 6, CAL, S.CAL	dF1 t		5.61 / 47

4.14 Relay table

Record your relay settings in the table below

Display	Alarm 1	Alarm 2	Alarm 3	Alarm 4	Alarm 5	Alarm 6	Alarm 7	Alarm 8
H, Gh								
Lo								
HYS t								
t r, P								
rSt								
rLYS								
Ltch								

Record which relays are allocated to which alarms and other relay settings in the table below

Display	Relay 1	Relay 2	Relay 3	Relay 4	Relay 5	Relay 6	Relay 7
Alarm 1							
Alarm 2							
Alarm 3							
Alarm 4							
Alarm 5							
Alarm 6							
Alarm 7							
Alarm 8							
FLY							
AcF							
booi							

5 Explanation of functions

The setup and calibration functions are configured through a push button sequence. The three push buttons located at the front of the instrument are used to alter settings. The access modes available are detailed in section 1.2, starting on page 3.

Display messages shown are those which would appear on a 6 digit display, these display messages may in some cases vary slightly for other display types.

Explanation of Functions

5.1 Alarm relay high setpoint

Section:	AL 1 to AL 8
Display:	H, 9h
Range:	Any display value or OFF
Default Value:	OFF
Default Access Level	2
Function number	4000 to 4007

Displays and sets the high setpoint value for the designated alarm. Use this high setpoint function if an alarm operation is required when the display value becomes equal to or greater than the required setpoint value.

To set the high alarm value go to the **H, 9h** function, press **F** and when you see a digit of the value flash use the **▲** or **▼** push buttons to set the required value then press **F** to accept this selection. The high alarm setpoint may be disabled by pressing the **▲** and **▼** push buttons simultaneously. When the alarm is disabled the display will indicate **OFF**. If the alarm is allocated both a low and high setpoint then the alarm will activate when the value displayed moves outside the band set by the low and high setpoints. The value at which the alarm will reset is controlled by the **HYS** function. The relay or relays to be used with this alarm can be selected (set to on or off) at the **FLY** function for each alarm.

Overlapping alarms - if the **H, 9h** value is set lower than the **Lo** value then the alarm will activate in the band between the two values.

If the display has annunciator leds for the alarm then the annunciator will initially flash in alarm condition, if the alarm is acknowledged by pressing the **F** button the annunciator will be solidly lit until the display moves out of alarm condition.

Example:

If **H, 9h** under **AL 1** is set to **100** then alarm 1 will activate when the display value is **100** or higher. Any relay allocated to this alarm will also activate.

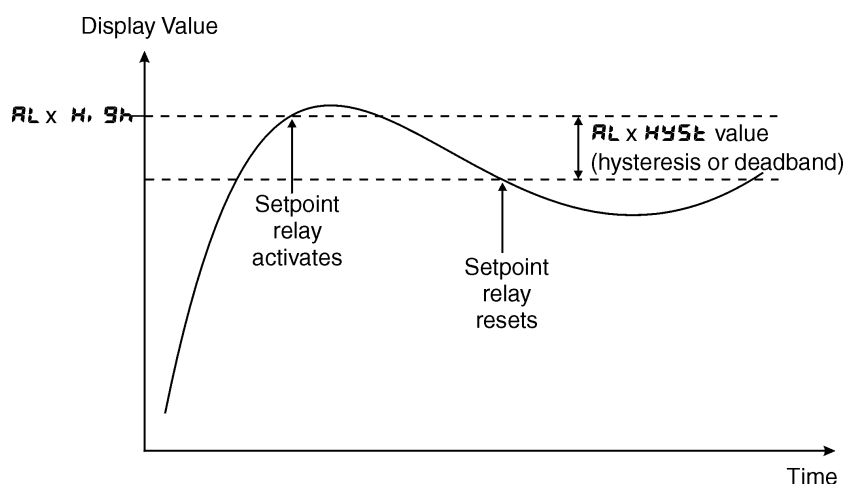

5.2 Alarm relay low setpoint

Section:	AL 1 to AL 8
Display:	Lo
Range:	Any display value or OFF
Default Value:	OFF
Default Access Level	2
Function number	40 10 to 40 17

Displays and sets the low setpoint value for the designated alarm.

Use this low setpoint function if a relay operation is required when the display value becomes equal to or less than the required setpoint value.

To set the low alarm value press **F** and when you see a digit of the value flash use the **▲** or **▼** push buttons to set the required value then press **F** to accept this selection.

The low alarm setpoint may be disabled by pressing the **▲** and **▼** push buttons simultaneously. When the alarm is disabled the display will indicate **OFF**. If the alarm is allocated both a low and high setpoint then the alarm will activate when the value displayed moves outside the band set by the low and high setpoints. The value at which the alarm will reset is controlled by the Hysteresis function. The relay or relays to be used with this alarm can be selected (set to on or off) at the **RLY** function for each alarm.

If the display has annunciator leds for the alarm then the annunciator will initially flash in alarm condition, if the alarm is acknowledged by pressing the **F** button the annunciator will be solidly lit until the display moves out of alarm condition.

Overlapping alarms - if the **H_h** value is set lower than the **Lo** value then the alarm will activate in the band between the two values.

Example:

If **Lo** under **AL 1** is set to **10** then relay 1 will activate when the display value is 10 or less. Any relay allocated to this alarm will also activate

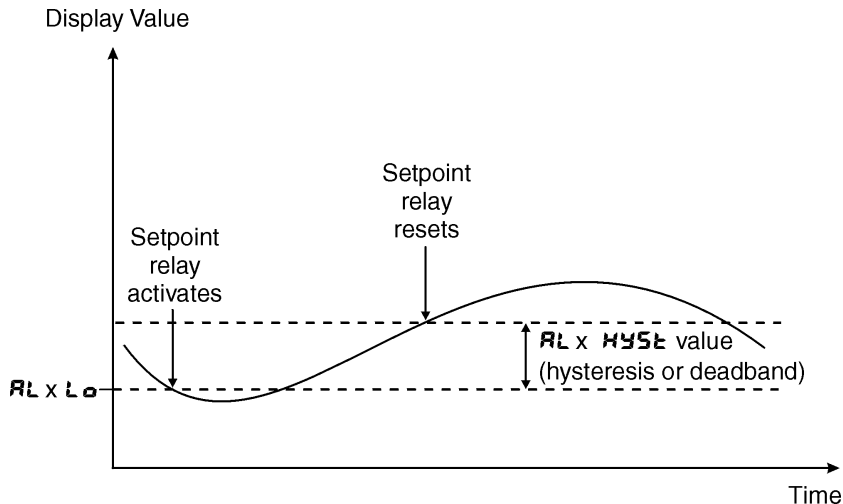

5.3 Alarm hysteresis (deadband)

Section:	AL 1 to AL 8
Display:	HYSL
Range:	0 to 50000
Default Value:	10
Default Access Level	3
Function number	4020 to 4027

Displays and sets the alarm hysteresis limit for the designated alarm. To set a alarm hysteresis value go to the function and use the **▲** or **▼** push buttons to set the value required then press **F** to accept this value. The hysteresis value is common to both high and low setpoint values. The hysteresis value may be used to prevent too frequent operation of the alarm and associated relays when the measured value is rising and falling around setpoint value. e.g. if **HYSL** under **AL 1** is set to zero the alarm will activate when the display value reaches the alarm setpoint (for high alarm) and will reset when the display value falls below the setpoint, this can result in repeated on/off switching of relays at around the setpoint value.

The hysteresis setting operates as follows: In the high alarm mode, once the alarm is activated the input must fall below the setpoint value minus the hysteresis value to reset the alarm. e.g. if **H, 9h** under **AL 1** is to **50.0** and **HYSL** is set to **3.0** then the setpoint alarm will activate once the display value goes to **50.0** or above and will reset when the display value goes below **47.0** i.e. at **46.9** or below. In the low alarm mode, once the alarm is activated the input must rise above the setpoint value plus the hysteresis value to reset the alarm. e.g. if **L0** is to **20.0** and **HYSL** is set to **10.0** then the alarm will activate when the display value falls to **20.0** or below and will reset when the display value goes above **30.0** i.e. at **30.1** or above.

To set the hysteresis value go to the **HYSL** function, press **F** and when you see a digit of the value flash use the **▲** or **▼** push buttons to set the required value then press **F** to accept this selection. The hysteresis units are expressed in displayed engineering units.

Example: If **H, 9h** is set to **100** and **HYSL** is set to **10** then alarm 1 will activate when the display value is **100** or higher and will reset at a display value of **89** or lower.

5.4 Alarm relay trip time

Section:	AL 1 to AL 8
Display:	TR, P
Range:	0 to 5000.0 secs
Default Value:	0.0
Default Access Level	3
Function number	4040 to 4047

Displays and sets the alarm trip time in seconds. The trip time is common for both alarm high and low setpoint values. The trip time provides a time delay before the alarm relay will activate when an alarm condition is present. The alarm condition must be present continuously for the whole trip time period before the alarm will activate. If the input moves out of alarm condition during this period the timer will reset and the full time delay will be restored. This trip time delay is useful for preventing an alarm trip due to short non critical deviations from setpoint. The trip time is selectable over **0** to **50000** seconds.

To set the trip time value go to the **TR, P** function, press **F** and when you see a digit of the value flash use the **▲** or **▼** push buttons to set the required value then press **F** to accept this selection.

Example: If **TR, P** is set to **5** seconds then the display must indicate an alarm value for a full 5 seconds before the relay will activate.

5.5 Alarm relay reset time

Section: **AL 1 to AL 8**
Display: **rSt**
Range: **0 to 5000.0** secs
Default Value: **0.0**
Default Access Level **3**
Function number **4050 to 4057**

Displays and sets the alarm reset delay time in seconds. The reset time is common for both alarm high and low setpoint values. With the alarm condition is removed the alarm relay will stay in its alarm condition for the time selected as the reset time. If the input moves back into alarm condition during this period the timer will reset and the full time delay will be restored. The reset time is selectable over **0 to 50000** seconds.

To set the reset time value go to the **rSt** function, press **F** and when you see a digit of the value flash use the **▲** or **▼** push buttons to set the required value then press **F** to accept this selection.

Example: If **rSt** is set to **10** seconds then the resetting of alarm relay will be delayed by 10 seconds.

5.6 Relay selection

Section: **AL 1 to AL 8**
Display: **FLYS**
Range: **On** or **OFF**
Default Value: **OFF**
Default Access Level **4**
Function number **4330 to 4337**

Allows a relay to be allocated to an alarm. For example if a high alarm value has been selected at the **AL 1 FLYS** function this alarm could be allocated to relay 3 by selecting **FLY3 On** at this function. Press the **F** button to enter this function then use the **▲** or **▼** pushbuttons to choose the required relay then press the **F** button to toggle to **On** or **OFF** as required.

5.7 Alarm relay latching operation

Section: **AL 1 to AL 8**
Display: **Ltch**
Range: **Auto, Ltch**
Default Value: **Auto**
Default Access Level **4**
Function number **4170 to 4177**

Allows selection of alarm latching operation. If set to **Auto** the alarm relays will not latch i.e. they will automatically reset when the display moves out of alarm condition. If set to **Ltch** the relay will latch and will not reset until the display value is out of alarm condition and either the **F** button is pressed to clear the latch condition or if power is removed. The relay hysteresis, trip time and reset time settings still apply to latching relays.

In latching mode the alarm annunciator (5 digit display type only) will flash when the display goes into alarm condition. If the display goes out of alarm condition without being acknowledged the flashing period will change to give a longer "off" time. If the alarm is acknowledged by pressing the **F** button then the annunciator will change from flashing to solidly lit. Once the alarm has been acknowledged the relay will be free to reset once the display value moves out of alarm condition.

5.8 Alarm relay normally open/closed

Section:	FL 1 to FL 7
Display:	FLY
Range:	n.o, n.c
Default Value:	n.o
Default Access Level	4
Function number	4030 to 4036

Displays and sets the setpoint alarm relay x action to normally open (de-energised) or normally closed (energised), when no alarm condition is present. Since the relay will always open when power is removed a normally closed alarm is often used to provide a power failure alarm indication. To set the alarm relay for normally open or closed go to the **FL 1 to FL 7 FLY** function and use the **▲** or **▼** push buttons to set the required operation then press **F** to accept this selection. **Example:**

If set to **n.o** alarm relay 1 will be open circuit when the display is outside alarm condition and will be closed (short circuit across COM and N/O terminals) when the display is in alarm condition.

5.9 Relay acknowledge

Section:	FL 1 to FL 7
Display:	ACK
Range:	OFF or ON
Default Value:	OFF
Default Access Level	4
Function number	4320 to 4326

If the **ACK** is set to **ON** the operator can acknowledge the alarm whilst still in alarm condition allowing the relay to reset straight away. This is not affected by the alarm being set to either latching or auto reset mode. The acknowledge can be made by pressing the front **F** button, if available. The front **P** button and/or a remote input can also be programmed to be used in acknowledging the alarm.

5.10 Alarm relay Boolean logic operation

Section:	FL 1 to FL 7
Display:	bool
Range:	Or, And
Default Value:	Or
Default Access Level	4
Function number	4310 to 4316

This function allows a Boolean logic AND (**And**) or OR (**Or**) function to be applied to alarms. If two or more alarms use the same relay and that relay is set to operate as an OR operation then this effectively puts the alarms in parallel. If two or more alarms use the same relay that relay is set to operate on an AND operation then this effectively puts the alarms in series.

Examples: 1. If alarms 1, 2 and 3 all use relay 1 and relay 1 is set for **Or** operation then relay 1 will activate if the display value for the selected channels for these alarms causes either alarm 1 or alarm 2 or alarm 3 to go into alarm condition. i.e. relay 1 will activate if any of the alarms is in alarm condition.

2. If alarms 1, 2 and 3 all use relay 1 and relay 1 is set for **And** operation then relay 1 will activate if the display value for the selected channels for these alarms causes alarm 1 and alarm 2 and alarm 3 to go into alarm condition. i.e. all 3 alarms must be in alarm condition for relay 1 to activate.

5.11 Output selection for analog output 1

Section: **FO1**
Display: **OUTP**
Range: **4-20.0-10.0-10**
Default Value: **4-20**
Default Access Level **4**
Function number **4140**

Seen only when 16 bit analog retransmission option with choice of outputs is fitted. If the 4-20mA only output is fitted then this function will not be seen. Sets the output type for the 16 bit analog output. Choices are:

- **4-20** for 4 to 20mA output
- **0-10** for 0 to 1VDC output
- **0-10** for 0 to 10VDC output

To set the selection go to the **OUTP** function, press **F** and when you see a digit of the value flash use the **▲** or **▼** push buttons to set the required value then press **F** to accept this selection.

5.12 Analog output 1 option low value

Section: **FO1**
Display: **Lo**
Range: Any display value
Default Value: **0**
Default Access Level **4**
Function number **4120**

Seen only when analog retransmission option fitted. Refer to the separate “PM5 Meter Optional Output Addendum” booklet supplied when this option is fitted for wiring details.

Displays and sets the analog retransmission output low value (4mA or 0V) in displayed engineering units. To set the selection go to the **Lo** function, press **F** and when you see a digit of the value flash use the **▲** or **▼** push buttons to set the required value then press **F** to accept this selection.

Example: If it is required to retransmit 4mA when the display indicates **0** then select **0** in this function using the **▲** or **▼** button.

5.13 Analog output option high value

Section: **FO1**
Display: **H, 9h**
Range: Any display value
Default Value: **1000**
Default Access Level **4**
Function number **4130**

Seen only when analog retransmission option fitted. Refer to the separate “PM5 Meter Optional Output Addendum” booklet supplied when this option is fitted for wiring details.

Displays and sets the analog retransmission output high display value (20mA, 1V or 10V) in displayed engineering units.

To set the value go to the **H, 9h** function, press **F** and when you see a digit of the value flash use the **▲** or **▼** push buttons to set the required value then press **F** to accept this selection.

Example: If it is required to retransmit 20mA when the display indicates **50** then select **50** in this function using the **▲** or **▼** button.

5.14 Output selection for analog output 2

Section: **ꠞ02**
Display: **0ꠞtꠞ**
Range: **4-20, 0-1.0** or **0-10**
Default Value: **4-20**
Default Access Level **4**
Function number **4141**

Seen only when dual 16 bit analog retransmission option fitted. Sets the output type for the 16 bit analog output. Choices are:

4-20 for 4 to 20mA output
0-1.0 for 0 to 1VDC output
0-10 for 0 to 10VDC output

To set the selection go to the **0ꠞtꠞ** function, press **F** and when you see a digit of the value flash use the **▲** or **▼** push buttons to set the required value then press **F** to accept this selection.

5.15 Analog output 2 option low value

Section: **ꠞ02**
Display: **Lo**
Range: Any display value
Default Value: **0**
Default Access Level **4**
Function number **4121**

Seen only when dual analog retransmission option fitted. See function **ꠞ01Lo** for further details.

5.16 Analog output option 2 high value

Section: **ꠞ02**
Display: **H, 9h**
Range: Any display value
Default Value: **1000**
Default Access Level **4**
Function number **4131**

Seen only when dual analog retransmission option fitted. See function **ꠞ01H, 9h** for further details.

5.17 Operating mode

Section: **CONF**
Display: **OPER**
Range: **run, dur, PLSE, SngL, PLS.H, Sng.H, UP, dn, d.run**
Default Value: **run**
Default Access Level: **4**
Function number: **4074**

Displays and sets the operation mode to be used in measuring the pulse period. All of the modes are up timers with the exception of the **dn** and **d.run** modes.

Mode	Operation
run (run)	The run option allows accumulated time display. The mode operates in the following manner: Input inactive: The timer stops but holds the time display. Input active: The timer continues timing from the previous time i.e. the time accumulates.
dur (duration)	The duration option allows display of an input time with a reset at the end of the input. The mode operates in the following manner: Input inactive: The timer is automatically reset and the display shows zero or the preset value. Input active: The timer starts timing from zero or the preset value.
PLSE (pulse)	The pulse option allows timing of the duration of an input pulse. The mode operates in the following manner: Input inactive: The display will hold the time of the last pulse. Input active: The display resets to zero (preset does not apply to this mode) then starts timing the new pulse.
SNGL (single pulse)	The single pulse option allows timing of the duration of a pulse. The mode operates in the following manner: Input inactive: The display will hold the time of the last pulse. The display must be reset before a new pulse can be timed. Input active: If the previous time display has been reset then the timing process will start from zero or the preset value. If the previous display has not been reset the value displayed will not change when the input becomes active.
PLS.H (pulse held)	The pulse held option operates in the same manner as the PLSE option with the exception that the display indication only changes at the end of the active input i.e. the previous display is held until the new active input ends.
SNGL.H (single pulse held)	The pulse held option operates in the same manner as the SNGL option with the exception that the display indication only changes at the end of the input pulse. As with the SNGL option the display must be reset before a new pulse can be timed.
UP (up timer)	The up timer option allows the instrument to be used as a timer with a start, stop and reset input. The mode operates in the following manner: Upon receiving an active input the display will show accumulated time. This timing will continue until a STOP input is received even if the input becomes inactive. This STOP input is operated via an edge between the Input 2 IN and GND terminals. A reset input will reset the timer to zero. If the timer is stopped and then restarted without a reset the timing will continue from the previous time.
dn (down timer)	The down timer works in the same manner as the UP timer with the exception that the down timing will automatically start from the time set at the P.SET function.
d.run (down timer run mode)	The mode operates in the following manner: Input active: Display starts timing from preset value or the previous time recorded. Input inactive: Display holds time. A preset (or reset to preset) operation must be carried out when the time needs to be reset.

5.18 Time display range

Section:	CONF
Display:	TIME
Range:	SECS, m.m.SS, h.m.S, mm, hh.mm, hrS, dd.hh, DAYS
Default Value:	SECS
Default Access Level	4
Function number	4074

Allows setting of the display time range. Choices are:

SECS for a display in seconds

m.m.SS for a display in minutes and seconds.

h.m.S for a display in hours, minutes and seconds.

mm for a display in minutes.

hh.mm for a display in hours and minutes.

hrS for a display in hours.

dd.hh for a display in days and hours.

DAYS for a display in days.

Note that the display is also affected by the decimal point setting. Examples below show how a 100 second display is affected by the display range. Examples are shown for a 4 digit display type instrument.

5.19 Decimal point

Section:	CONF
Display:	d.Pnt
Range:	0, 0.1, 0.02, 0.003
Default Value:	0
Default Access Level	4
Function number	4100

Displays and sets the decimal point for the period display. The decimal point function display shown will depend on the number of digits in the display and the **CONF TIME** setting. The table below shows settings for a 4 digit display.

CONF FnGE	CONF d.Pnt	Measuring units
SECS	0	Seconds
SECS	0.1	Seconds and tenths of seconds
SECS	0.02	Seconds and hundredths of a second
SECS	0.003	Seconds and thousandths of a second
mm.SS	0	Minutes and seconds
mm.SS	0.1	Minutes and seconds and tenths of a second
mm.SS	0.02	Seconds and hundredths of a second
mm.SS	0.003	Seconds and thousandths of a second
mm	0	Minutes
mm	0.1	Minutes and tenths of a minute
mm	0.02	Minutes and hundredths of a minute
mm	0.003	Minutes and thousandths of a minute
hh.mm	0	Hours and minutes
hh.mm	0.1	Hours, minutes and tenths of a minute e.g. 1.33.7
hh.mm	0.02	Minutes and hundredths of a minute
hh.mm	0.003	Minutes and thousandths of a minute
hrS	0	Hours
hrS	0.1	Hours and tenths of an hour
hrS	0.02	Hours and hundredths of an hour
hrS	0.003	Hours and thousandths of an hour
dd.hh	0	Days and hours
dd.hh	0.1	Days, hours and tenths of an hour e.g. 3.15.2
dd.hh	0.02	Hours and hundredths of an hour
dd.hh	0.003	Hours and thousandths of an hour
dAYS	0	Days
dAYS	0.1	Days and tenths of a day
dAYS	0.02	Days and hundredths of a day
dAYS	0.003	Days and thousandths of a day

5.20 Preset

Section: **CONF**
Display: **P.SET**
Range: Any display value
Default Value: **0**
Default Access Level: **2**
Function number: **4C78**

This function displays and sets the preset value to be used when the reset mode is set to go to the preset value rather than zero. Resetting to a preset value is most commonly used when down timing from a preset value.

5.21 Reset mode

Section: **CONF**
Display: **F.SET**
Range: **F.SET, P.SET**
Default Value: **F.SET**
Default Access Level: **4**
Function number: **4C96**

The reset terminal can be programmed to cause the display to reset to either zero (**F.SET**) or the preset value set via the **CONF P.SET** function. If a hardware reset via the **P** button or input 2 or a remote

input is used then these hardware inputs will follow this function . This function is used mainly to set the reset or preset for timer modes which automatically reset or preset e.g. at the start of a new pulse, without the need for a hardware input.

5.22 Stop at zero

Section: **CONF**
 Display: **STOP ZERO**
 Range: **OFF** or **ON**
 Default Value: **OFF**
 Default Access Level **4**
 Function number **4C98**

This function is only available when the down timer mode is selected at the **CONF OPER** function. When set to **ON** the down count will stop at zero. When set to **OFF** the timer will continue through zero to show negative value if the timer operation is still active.

5.23 Display running indication

Section: **CONF**
 Display: **RUN FLASH**
 Range: **OFF** or **ON**
 Default Value: **ON**
 Default Access Level **4**
 Function number **4C9A**

The colons and/or decimal point depending on display type on the display can be set to flash when the display is running (timing up or down) (**RUN FLASH** set to **ON**) or can be set not to flash at any time (**RUN FLASH** set to **OFF**). The flashing mode is useful to indicate the display is running when the display is set for minutes, hours or days.

5.24 Reset at power up

Section: **CONF**
 Display: **P.ON FSE**
 Range: **OFF, F.SET, P.SET**
 Default Value: **OFF**
 Default Access Level **4**
 Function number **4C96**

When set to **F.SET** the display will reset to zero each time it is powered up. When set to **P.SET** the display will to the preset value each time it is powered up. This function can be disabled by setting it to **OFF**

5.25 Bargraph type



Section: **bAr9**
Display: **tYPE**
Range: **bAr**, **S.dot**, **d.dot** or **c.bAr**
Default Value: **bAr**
Default Access Level **4**
Function number **43F0**

Seen only in bargraph display instruments. Displays and sets the bargraph display type Choices are:

- **bAr** - conventional solid bargraph display i.e. all LEDs illuminated when at full scale.
- **S.dot** - single dot display. A single segment will be lit to indicate the input readings position on the scale.
- **d.dot** - double dot display. Two segments will be lit to indicate the input reading position on the scale. The reading should be taken from the middle of the two segments.
- **c.bAr** - centre bar display. The display will be a solid bargraph but will have its zero point in the middle of the display. If the seven segment display value is positive the bargraph will rise. If the seven segment display value is negative then the bargraph will fall.

5.26 Bargraph low value

Section: **bAr9**
Display: **Lo**
Range: Any display value
Default Value: **0**
Default Access Level **4**
Function number **43F2**

Seen only in bargraph display instruments. Displays and sets the bar graph low value i.e. the value on the 7 segment display at which the bargraph will start to rise. This may be independently set anywhere within the display range of the instrument. Note: The **bAr9Lo** and **bAr9H** settings are referenced from the 7 segment display readings, not the bargraph scale values. The bargraph scale may scaled differently to the 7 segment display. For example the bargraph scale may be indicating percentage whilst the 7 segment display is indicating actual process units. To set bargraph low level go to the **bAr9Lo** function and use the  or  push buttons to set the value required then press  to accept this value.

5.27 Bargraph high value

Section: **bAr9**
Display: **H**
Range: Any display value
Default Value: **1000**
Default Access Level **4**
Function number **43F4**

Seen only in bargraph display instruments. Displays and sets the bar graph high value i.e. the value on the 7 segment display at which the bargraph will reach its maximum indication. This may be independently set anywhere within the display range of the instrument. Note: The **bAr9Lo** and **bAr9H** settings are referenced from the 7 segment display readings, not the bargraph scale values. The bargraph scale may scaled differently to the 7 segment display. For example the bargraph scale may be indicating percentage whilst the 7 segment display is indicating actual process units. To set bargraph low level go to the **bAr9**

H function and use the **▲** or **▼** push buttons to set the value required then press **F** to accept this value.

5.28 Input 2 operation mode

Section: **1 A 2**
Display: **OPER**
Range: **None, FSt, P.St**
Default Value: **None**
Default Access Level **4**
Function number **4C2 1**

This function sets the operation mode for input 2. Input 2 can be set for no operation **None**, to operate as a reset to zero input **FSt** or to operate as a reset to preset value input **P.St**. Note in **UP** and **dn** timer operation modes this function will not be seen as input 2 will always be used as the “Stop” input in these modes. In **UP** and **dn** timer operation modes one of the remote inputs must be programmed for use as a reset or preset input. Also note that in the **CONF** section there are functions for setting the preset value and the reset/preset operation mode which can also control if the display resets to zero or resets to a preset value.

5.29 Input pull up

Section: **1 A 1 to 1 A 2**
Display: **PULL UP**
Range: **Open, H, 9h, Lo**
Default Value: **H, 9h**
Default Access Level **4**
Function number **4C00 to 4C0 1**

Allows electrical pull up or pull down setting of the signal input 1 and count up/down input 2. When set to **H, 9h** approximately 5VDC will be placed on the input internally. When set to **Lo** the input will be pulled down to 0V (signal ground). When set to **Open** signals up to 48VDC can be applied. See “Electrical Installation” chapter for further information.

5.30 Input bias

Section: **1 A 1 to 1 A 2**
Display: **bIAS**
Range: **OFF, On**
Default Value: **On**
Default Access Level **4**
Function number **4C02 to 4C03**

Allows electrical input bias setting of the signal input 1 and count up/down input 2. When set to **On** an input bias voltage will be applied to the input circuit. When set to **OFF** no bias voltage will be applied to the input circuit. This function should be set to **On** when the input signal does not go below 0V. See “Electrical Installation” chapter for further information.

5.31 Input low frequency

Section: **IN1 to IN2**
Display: **LoF**
Range: **OFF, On**
Default Value: **OFF**
Default Access Level **4**
Function number **4C04 to 4C05**

Allows application of a low pass filter setting for the signal input 1 and count up/down input 2. When set to **On** a low pass filter will be applied to the input circuit. When set to **OFF** no low pass filter will be applied to the input circuit. This function should be set to **On** for inputs likely to generate contact bounce such as switch and relay inputs but it can also be useful for blocking higher frequency signals when only low frequency inputs are being used. The filter will only allow signals of approx. 1KHz or lower to pass to the input stage when set for square wave input. For other input types the frequency will depend on input settings amplitude and type of waveform. See “Electrical Installation” chapter for further information.

5.32 Input hysteresis

Section: **IN1 to IN2**
Display: **HYSL**
Range: **OFF, On**
Default Value: **OFF**
Default Access Level **4**
Function number **4C06 to 4C07**

Allows application “hysteresis” setting for the signal input 1 and count up/down input 2. When set to **OFF** the input gain will be set for signals of 25mV to 250mV. When set to **On** the input gain will be set for signals above 250mV. When set to **OFF** the input will accept lower amplitude signals but will also be more likely to pick up electrical noise. See “Electrical Installation” chapter for further information.

5.33 Input attenuation

Section: **IN1 to IN2**
Display: **AttL**
Range: **OFF, On**
Default Value: **OFF**
Default Access Level **4**
Function number **4C08 to 4C09**

Allows application of a 5 times attenuation for the signal input 1 and count up/down input 2. When set to **OFF** no attenuation will be applied. When set to **On** the input signal will be reduced by a factor of 5 before moving on to the first amplification stage. Applying attenuation can be used to reduce the noise level of the input signal when the input signal itself is large enough to be attenuated e.g. a 0 to 20V square wave will become 0 to 4V square wave after attenuation. See “Electrical Installation” chapter for further information.

5.34 Input DC coupling

Section: 1A1 to 1A2
Display: dC
Range: OFF, On
Default Value: On
Default Access Level: 4
Function number: 4C0A to 4C0B

Allows application of DC coupling for the signal input 1 and count up/down input 2. When set to **OFF** no DC coupling be applied. When set to **On** DC coupling will be applied. DC coupling should be used (set to **On**) when using switch or relay inputs or when the input frequency is always going to be less than 10Hz. See “Electrical Installation” chapter for further information.

5.35 Input edge or level

Section: 1A1 to 1A2
Display: EdGE
Range: Lo, Hi
Default Value: Lo
Default Access Level: 4
Function number: 4C10 to 4C11

Allows selection of input edge or level for the signal input 1 and count up/down input 2. Select **Lo.E** for the input to be triggered by a low going edge i.e. falling from a voltage towards zero. Select **Hi.E** for the input to be triggered by a high going edge i.e. rising from a low voltage. See “Electrical Installation” chapter for further information.

5.36 Input de-bounce timer

Section: 1A1 to 1A2
Display: d.bnc
Range: 0 to 1000 ms
Default Value: 0
Default Access Level: 4
Function number: 4C18 to 4C19

Allows application of a de-bounce timer for the signal input terminal. A de-bounce time of between 0 and 1000mS can be set. When a de-bounce time is set the signal level before the input trigger signal must have been at that level for the de-bounce time or longer. This is used to help prevent false triggering due to relay or switch contact bounce or signals with high frequency noise. For example if the input is triggered by a high level or high going edge and the de-bounce time is set to 10mS then the input would have to be at a low level for at least 10mS before the input is triggered, if not then the input trigger will not be accepted. At a setting of 10mS (assuming a symmetrical waveform with period of 20mS (2 x 10mS)) frequencies above approx. 50Hz (1/20mS) will be rejected and not totalised or shown as rate value. Similarly a setting of 20mS (assuming period of 40mS) would reject frequencies above approx. 25Hz. See “Electrical Installation” chapter for further information.

5.37 Output voltage selection

Section: **P.Out**
Display: **P.Out**
Range: **5U, 12** or **18U**
Default Value: **5U**
Default Access Level **4**
Function number **4C0F**

Allows selection of the output voltage where available on the input board. 5V 12V or 18VDC (25mA max.) is available as transmitter supply this function allow selection of 5V (**5U**) or 12V (**12U**) or 18V (**18U**). Transmitter supply voltages are approximate.

5.38 Front P button operation mode

Section: **F.F NP**
Display: **P.but**
Range: **NONE, P.Hi, P.Lo, Hi .Lo, AL.Ac, FSEt, PSEt**
Default Value: **NONE**
Default Access Level **4**
Function number **4720**

Sets the operation mode for front **P** button. Functions available are identical to the same functions used in the **F.F N. 1** function.

5.39 Remote input 1 operation mode

Section: **F.F NP**
Display: **F.F N. 1** to **F.F N. 2**
Range: **NONE, P.Hi d, d.Hi d, P.Hi, P.Lo, Hi .Lo, AL.Ac, ACCS, dult, FSEt, PSEt**
Default Value: **NONE**
Default Access Level **4**
Function number **4721** to **4722**

Sets the operation mode for remote input 1 terminal. Choices are as follows:

- **NONE** - If this option is selected then remote input 1 will have no function.
- **P.Hi d** - peak hold. The display will show the peak value only whilst the remote input terminals are short circuited i.e. the display value can rise but not fall whilst the input terminals are short circuited. The message **P.Hi d** will appear briefly every 8 seconds whilst the input terminals are short circuited to indicate that the peak hold function is active.
- **d.Hi d** - display hold. The display value will be held whilst the remote input terminals are short circuited. The message **d.Hi d** will appear briefly every 8 seconds whilst the input terminals are short circuited to indicate that the display hold function is active. Although the display is frozen if the timer is active the timer will continue in the background and will show the time when the remote input is released.
- **P.Hi** - peak memory. The peak value stored in memory will be displayed if the remote input terminals are short circuited, if the short circuit is momentary then the display will return to normal measurement after 20 seconds. If the short circuit is held for 2 to 3 seconds or the power is removed from the instrument then the memory will be reset, a **rSt** message will be seen if the memory is reset by holding a short circuit for 2 to 3 seconds.

- **P.Lo** - valley memory. The minimum value stored in memory will be displayed. Otherwise operates in the same manner as the **P.H**, function described above.
- **H, Lo** - toggle between **H**, and **Lo** displays. This function allows the remote input to be used to toggle between peak and valley memory displays. The first operation of the remote input will cause the peak memory value to be displayed, the next operation will give a valley memory display. **P.H**, or **P.Lo** will flash before each display to give an indication of display type.
- **AL.AC** - alarm acknowledge. Allows the remote input to be used to acknowledge an alarm. If the alarm is set for latching operation the acknowledgment will allow the alarm and any relays allocated to that alarm to reset when the alarm condition is removed. If the alarm is set for automatic reset the acknowledgment will allow the alarm and any relays allocated to that alarm to reset even if the alarm condition still exists this could typically be used to silence a siren controlled by a relay even though the alarm condition is still present. The acknowledge will operate on all alarms programmed to require acknowledgement.
- **ACCESS** - remote input access. Allows the remote input to be used for setup function access control purposes. Refer to the “ Accessing setup functions” in the Introduction chapter.
- **dui 1** - remote dulling of the display. When activated the display brightness will fall to the level set by the **di SP dui 1** level. This is generally used to reduce current consumption in battery powered applications or for switching between day and night brightness levels.
- **FSEt** - zero the display. This mode allows the remote input to be used as a reset to zero. This setting will be typically used to allow the remote input to be used as the reset input in **UP** and **dn** modes.
- **PSEt** - preset the display. This mode allows the remote input to be used as a set display to the preset value the preset value is set at the **CONF P.SEt** function. This setting will be typically used to allow the remote input to be used as the preset input in **UP** and **dn** modes.

5.40 Remote input 2 operation mode

Section:	F.I OP
Display:	F.I N.2
Range:	NONE, P.Hi d, d.Hi d, P.H, , P.Lo, H, .Lo, AL.Ac, ACCESS, dui 1 , FSEt, PSEt
Default Value:	NONE
Default Access Level	4
Function number	4722

Remote input 2 functions. Same choices as **F.I OP F.I N. 1** apply.

5.41 Display brightness

Section:	di SP
Display:	br 9t
Range:	1 to 16
Default Value:	16
Default Access Level	2
Function number	22Fb

Displays and sets the dulled digital display brightness. The display brightness is selectable from 1 to 16, where 1 = lowest intensity and 15 = highest intensity. This function is useful for improving the display readability in dark areas or to reduce the power consumption of the instrument. See also the **dui 1** function.

To set brightness level go to the **br9t** function press **F** and when you see a digit of the value flash use the **▲** or **▼** push buttons to set the required value then press **F** to accept this selection.

5.42 Dimmed display brightness

Section: **d: SP**
Display: **dul 1**
Range: **0** to **16**
Default Value: **2**
Default Access Level **2**
Function number **22EC**

Displays and sets the level for remote input brightness switching. When a remote input is set to **dul 1** the remote input can be used to switch between the display brightness level set by the **br9t** function and the dimmed display brightness set by the **dul 1** function. The display dull level is selectable from **0** to **16**, where **0** = lowest intensity and **16** = highest intensity. This function is useful in reducing glare when the display needs to be viewed in both light and dark ambient light levels.

5.43 Serial operation mode

Section: **SEr1**
Display: **OPER**
Range: **NonE**, **Cont**, **Pol 1**, **R.buS**, **d: SP** or **ñ.buS**
Default Value: **NonE**
Default Access Level **4**
Function number **4480**

Allows selection of the operating mode to be used for serial RS232 or RS485 communications. See the “PM5 Panel Meter Optional Output Addendum” Choices are:

- **NonE** - no serial comms. required.
- **Cont** - sends ASCII form of display data at a rate typically 90% of the sample rate.
- **Pol 1** - controlled by computer or PLC etc. as host. The host sends command via RS232/485 and instrument responds as requested.
- **R.buS** - this is a special communications mode used with Windows compatible optional PC download software. Refer to the user manual supplied with this optional software.
- **d: SP** - sends image data from the display without conversion to ASCII. This mode should only be used when the serial output is connected to another display from the same manufacturer.
- **ñ.buS** - Modbus RTU.

5.44 Serial baud rate

Section: **SEr1**
Display: **bAud**
Range: **1200**, **2400**, **4800**, **9600**, **19.2**, **38.4**, **57.6**, **115.2**
Default Value: **9600**
Default Access Level **4**
Function number **4484**

Allows the baud rate to be set for serial communications. Choices are:

1200.2400.4800.9600.19200.38400.57600 or 115200

5.45 Serial parity

Section: **SErI**
Display: **PrEtY**
Range: **8n, 8E, 8O, 7E, 7O**
Default Value: **8n**
Default Access Level **4**
Function number **4482**

Allows selection of the parity check. The parity check selected should match that of the device it is being communicated with.

5.46 Serial address

Section: **SErI**
Display: **Unit Addr**
Range: **1 to 127**
Default Value: **1**
Default Access Level **4**
Function number **0430**

Allows selection of the unit address when the operation is set for **POLL** mode. The unit address is offset by 32(DECIMAL) to avoid clashing with ACSII special characters, therefore 42 (DECIMAL) or 2A (HEX) would be unit address 10.

5.47 Select number of alarms

Section: **ALCF**
Display: **AL Cnt**
Range: **0, 1, 2, 3, 4, 5, 6, 7, 8**
Default Value: **2**
Default Access Level **4**
Function number **437d**

Allows selection of the number of alarms required from 0 (**0**) to 8 (**8**).

5.48 Easy access mode

Section: **ACCES**
Display: **EASY LEVL**
Range: **NONE, 1, 2, 3, 4, 5, 6, CAL**
Default Value: **NONE**
Default Access Level **5.CAL**
Function number **0C00**

Allows choice of the access level available when using the easy access method. For example if this function is set to **3** then functions with levels 1, 2 and 3 can be viewed and changed when access to setup functions is made using this method. To access setup functions using the easy access method press and hold the **F** button until the message **FUNC** is seen followed by the first function message, this should take approximately 3 seconds. If the message **FUNC End** or no response is seen at this point it means that the access level has been set to **None** and that access to setup functions has been refused.

5.49 Remote input access mode

Section: **ACCES**
Display: **FUNC LEVL**
Range: **NONE, 1, 2, 3, 4, 5, 6, CAL**
Default Value: **NONE**
Default Access Level **S.CAL**
Function number **0C01**

This function allows choice of the access level available when using the remote input access method. To access setup functions using the remote input access method one of the remote inputs must be set to **ACCES** and the chosen remote input must be shorted to ground. Press and hold the **F** button until the message **FUNC** is seen followed by the first function message, this should take approximately 3 seconds. If the message **FUNC End** is seen at this point it means that the access level has been set to **NONE**.

5.50 PIN code 1

Section: **ACCES**
Display: **USF. 1 P. n**
Range: **0 to 50000**
Default Value: **0**
Default Access Level **S.CAL**
Function number **0C09**

This function allows choice of the PIN code to be used for PIN code input access method. Associated with the PIN is an access level (see **P. n. 1ACC5**). If a PIN is not required leave the setting at **0**. If a PIN other than 0 is chosen then this PIN must be entered to gain access to the the selected level.

To access setup functions using the PIN code input access method press then release the **F** button then within 2 seconds press the **▲** and **▼** buttons at the same time. The message **FUNC** is seen followed by the message **Code**. If the message **FUNC End** is seen at this point it means that the access level has been set to **NONE**. Use the **▲** and **▼** buttons to enter the PIN then press **F** to accept the PIN and proceed to the setup functions.

5.51 PIN code 1 access level

Section: **ACCES**
Display: **USF. 1 LEVL**
Range: **NONE, 1, 2, 3, 4, 5, 6, CAL**
Default Value: **NONE**
Default Access Level **S.CAL**
Function number **0C02**

This function allows choice of the access level available when using the PIN code 1 input access method. To access setup functions using the PIN code 1 input access method press and hold the **F** button until the message **FUNC** is seen followed by the first function message, this should take approximately 3 seconds. If the message **FUNC End** is seen at this point it means that the access level has been set to **NONE**.

5.52 PIN code 2

Section: **ACCES**
Display: **USF.2 P. n**
Range: **0 to 50000**
Default Value: **0**
Default Access Level **S.CAL**
Function number **0C0A**

This function allows choice of a second PIN code to be used for PIN code input access method. Associated with the PIN is an access level (see **P. n.2 Acc5**). The second PIN would normally be used to allow a second person to have a higher access to setup functions via a different PIN. If a second PIN is not required leave the setting at **0**. If a PIN other than 0 is chosen then this PIN must be entered to gain access to the the selected level.

To access setup functions using the PIN code input access method press then release the **F** button then within 2 seconds press the **▲** and **▼** buttons at the same time. The message **FUNC** is seen followed by the message **Code**. If the message **FUNC End** is seen at this point it means that the access level has been set to **None**. Use the **▲** and **▼** buttons to enter the PIN then press **F** to accept the PIN and proceed to the setup functions. Only one **Code** message will appear even though there can be a second PIN. If the number entered into the **Code** at this point is the PIN code 1 number then access will be granted to the functions allocated to the first PIN. If the PIN code 2 value is entered then access will be granted to the functions allocated to the second PIN.

5.53 PIN code 2 access level

Section: **ACCES**
Display: **USF.2 LEVL**
Range: **NONE, 1, 2, 3, 4, 5, 6, CAL**
Default Value: **NONE**
Default Access Level **S.CAL**
Function number **0C03**

This function allows choice of the access level available when using the PIN code 2 input access method. To access setup functions using the PIN code 2 input access method press and hold the **F** button until the message **FUNC** is seen followed by the first function message, this should take approximately 3 seconds. If the message **FUNC End** is seen at this point it means that the access level has been set to **None**.

5.54 User assignable access 1 function number

Section: **ACCES**
Display: **Fn. 1 Code**
Range: **0000 to FFFF hex.**
Default Value: **0000**
Default Access Level **S.CAL**
Function number **0C10**

In addition to being assigned an access level each setup function is assigned an individual function number. This functions and the ones which follow (**Fn.2 Code** etc.) can be used to alter the access level for particular functions. For example if the user wishes to change the access level of the channel 1 display units (function number 43A0) from level 5 to level 1 then the value **43A0** would be entered at this function and the value **3** would be entered at the function which follows. This would then enable the channel 1 display unit functions to be accessed at the lowest access level.

5.55 User assignable access 1 level value

Section: **ACCES**
Display: **Fn. 1 LEVL**
Range: **dFl t, 1, 2, 3, 4, 5, 6, CAL, S.CAL**
Default Value: **dFl t**
Default Access Level **S.CAL**
Function number **0C40**

Allows a new access level for the function with the number set in the function to be chosen. If **dFl t** is chosen then the level reverts back to the original default level.

5.56 User assignable access 2 function number

Section: **ACCES**
Display: **Fn.2 Code**
Range: **0000 to FFFF hex.**
Default Value: **0000**
Default Access Level **S.CAL**
Function number **0C11**

This function allows as second function access change and operates in the same manner as . Enter the function number required and then enter the new access level at the function which follows.

5.57 User assignable access 2 level value

Section: **ACCES**
Display: **Fn.2 LEVL**
Range: **dFl t, 1, 2, 3, 4, 5, 6, CAL, S.CAL**
Default Value: **dFl t**
Default Access Level **S.CAL**
Function number **0C41**

Allows a new access level for the function with the number set in the function to be chosen. If **dFl t** is chosen then the level reverts back to the original default level.

5.58 User assignable access 3 function number

Section: **ACCES**
Display: **Fn.3 Code**
Range: **0000 to FFFF hex.**
Default Value: **0000**
Default Access Level **S.CAL**
Function number **0C12**

This function allows as third function access change and operates in the same manner as . Enter the function number required and then enter the new access level at the function which follows.

5.59 User assignable access 3 level value

Section: **ACCES**
Display: **Fn.3 LEVL**
Range: **dFlt, 1, 2, 3, 4, 5, 6, CAL, S.CAL**
Default Value: **dFlt**
Default Access Level **S.CAL**
Function number **0C42**

Allows a new access level for the function with the number set in the function to be chosen. If **dFlt** is chosen then the level reverts back to the original default level.

5.60 User assignable access 4 function number

Section: **ACCES**
Display: **Fn.4 Code**
Range: **0000 to FFFF hex.**
Default Value: **0000**
Default Access Level **S.CAL**
Function number **0C13**

This function allows as fourth function access change and operates in the same manner as . Enter the function number required and then enter the new access level at the function which follows.

5.61 User assignable access 4 level value

Section: **ACCES**
Display: **Fn.4 LEVL**
Range: **dFlt, 1, 2, 3, 4, 5, 6, CAL, S.CAL**
Default Value: **dFlt**
Default Access Level **S.CAL**
Function number **0C43**

Allows a new access level for the function with the number set in the function to be chosen. If **dFlt** is chosen then the level reverts back to the original default level.

6 Specifications

6.1 Technical specifications

Input 1 and 2 :	Selectable for most sensor types. For inductive, AC and square wave inputs the maximum input voltage is 48VDC or RMS with appropriate input setting. Input 2 can be used as a reset to zero or preset input or as the Stop input in certain timer modes
Ambient temperature:	LED -10 to 60° C, LCD -10 to 50° C
Humidity:	5 to 95% non condensing
Display:	LED Models: 4 digit 20mm, 5 digit 14.2mm + status LEDs + 4 way keypad. 6 digit 14.2mm + 4 way keypad LCD Models: 4 digit 12.7mm, 6 digit 12.7mm
Power Supply:	AC 240V, 110V or 24V 50/60Hz or DC isolated wide range 12 to 48V. Note: supply type is factory configured.
Power Consumption:	AC supply 4 VA max, DC supply typically 80mA at 12VDC and 40mA at 24VDC for PM5 with no optional outputs, actual current drawn depends on display type and options fitted
Output (standard):	1 x relay, Form A, rated 5A resistive 5V or 18VDC transmitter supply 25mA max.
Relay Action:	Programmable N.O. or N.C

6.2 Output Options

Extra Relays:	1, 2, or 3 extra relays (form A, 3A @ 240VAC) First extra relay configurable as On/off alarm/control or PI control 6 extra relays (form A, 2A @ 240VAC) 5 extra relays (form A, 2A @ 240VAC) available only with serial retransmission
Analog Retransmission:	Isolated 12 bit 4-20mA output only single or dual channel or 16 bit single or dual channel 4-20mA, 0 to 1V or 0 to 10V analog output options 4 to 20mA output can drive into 800Ω load maximum Analog output 1 can be set for retransmission or PI control Analog output 2 retransmission or PI control
Serial Communications:	RS232 or RS485 or Ethernet

Output options are available in certain combinations e.g. Analog output plus extra relay, contact supplier for details.

6.3 Physical Characteristics

Bezel Size:	DIN 48mm x 96mm x 10mm
Case Size:	44mm x 91mm x 120mm behind face of panel
Panel Cut Out:	45mm x 92mm +1mm/-0mm
Connections:	Plug in screw terminals (max. 2.5mm ² wire)
Weight:	400 gms basic model

7 Guarantee and service

The product supplied with this manual is guaranteed against faulty workmanship for a period of two years from the date of dispatch.

Our obligation assumed under this guarantee is limited to the replacement of parts which, by our examination, are proved to be defective and have not been misused, carelessly handled, defaced or damaged due to incorrect installation. This guarantee is VOID where the unit has been opened, tampered with or if repairs have been made or attempted by anyone except an authorised representative of the manufacturing company.

Products for attention under guarantee (unless otherwise agreed) must be returned to the manufacturer freight paid and, if accepted for free repair, will be returned to the customers address in Australia free of charge.

When returning the product for service or repair a full description of the fault and the mode of operation used when the product failed must be given. In any event the manufacturer has no other obligation or liability beyond replacement or repair of this product.

Modifications may be made to any existing or future models of the unit as it may deem necessary without incurring any obligation to incorporate such modifications in units previously sold or to which this guarantee may relate.

This document is the property of the instrument manufacturer and may not be reproduced in whole or part without the written consent of the manufacturer.

This product is designed and manufactured in Australia.