

Model PM4-WT
Special Absolute Value Display Version
Panel Mount Display/Controller
Operation and Instruction Manual

AMALGAMATED INSTRUMENT CO PTY LTD

ACN: 001 589 439

*Unit 5, 28 Leighton Place Hornsby
NSW 2077 Australia*

*Telephone: +61 2 9476 2244
Facsimile: +61 2 9476 2902*

*e-mail: sales@aicpl.com.au
Internet: www.aicpl.com.au*

Table of Contents

1	Introduction	3
2	Mechanical Installation	5
3	Electrical installation	6
4	Function tables - summary of setup functions	10
5	Explanation of functions	15
6	Calibration	42
7	Batching operation	47
8	Specifications	49
9	Guarantee and service	51

1 Introduction

1.1 General description

This manual contains information for the installation and operation of the PM4-WT Load Cell Monitor special software version for absolute value display. The **ABS d: SP** function controls whether the display mode is standard (**ABS d: SP** function set to **OFF**) or absolute (**ABS d: SP** function set to **ON**). When the absolute value display mode is chosen and relays and optional retransmission outputs will operate from the absolute value.

Model PM4-WT is a high precision load cell/strain gauge monitor which may be configured to accept an input from any conventional 4 or 6 wire strain gauge bridge of 80Ω or higher. Sample rate is programmable in steps from 10 to 100 samples per second. The instrument has a full scale range of 0.5mV/V to 100mV/V, the mV range can be selected by the user.

The PM4-WT has various calibration method options. It may be calibrated by applying known force to the load cell or pressure sensor, by entering the mV/V value for the load cell, via a single offset value or via a “remote input” live calibration. Excitation voltages of 5 volt and 10 volt are selectable by PCB links, use 5 volts for less than 350Ω loads e.g. use 5V if more than one 350Ω load cells are connected in parallel.



The PM4 is suitable for measuring weight, pressure, force, torque and similar variables. Calibration, setpoint and other set up functions are easily achieved by push buttons (located at the rear panel and/or front panel depending on model). A standard inbuilt relay provides an alarm/control function. Alarms and retransmission may be set to operate from the live input value or to follow either the tare, batch, peak hold, display hold, peak memory or valley memory remote input operations.

The PM4 is available with a 4, 5, or 6 digit displays or combined bar graph plus 5 digit display to suit various applications. Unless otherwise specified at the time of order, your PM4 has been factory set to a standard configuration. Like all other PM4 series instruments the configuration and calibration is easily changed by the user. Initial changes may require dismantling the instrument to alter PCB links, other changes are made by push button functions.

Full electrical isolation between power supply, input voltage or current and retransmission output is provided by the PM4, thereby eliminating grounding and common voltage problems. This isolation feature makes the PM4 ideal for interfacing to computers, PLCs and other data acquisition devices.

PM4 panel mount monitors are designed for high reliability in industrial applications. The high brightness LED display provides good visibility, even in areas with high ambient light levels. A feature of the PM4-WT is the programmable display brightness function. This allows the unit to be operated with low display brightness to reduce the instrument power consumption and to improve readability in darker areas. The high contrast LCD displays provide good visibility and are ideal for battery powered applications.

Using the **i NPE** display to test input level

As an aid to testing and fault finding the  or  button can be used to toggle to a percentage display which is preceded by the message **i NPE**. Note that this **i NPE** message will only be available when the instrument is powered up with the  button held in until the **CAL** message is seen (first step of **CAL** mode). The **i NPE** display will show values **0.00** to **99.99**, inputs beyond **99.99** will show as “- - - -”. The “- - - -” message indicates that the mV input is too high for the range selected. The **i NPE** display is useful when testing/fault finding since it allows the user to view the live input mV as a percentage. This allows the user to check that the change in input level is within acceptable range and that the input mV is changing by the expected amount when

the load/pressure is changed. The message **! NPE** will flash momentarily once every 8 seconds whilst the percentage value is being viewed. To leave the **! NPE** display and return to normal process display requires the display to be toggled back to the normal display manually using the **▲** or **▼** button or for the display to be reset by removing power then powering up again.

The **FNSE** function setting determines the mV/V range for the internal analog to digital converter and hence the percentage displayed for any particular mV input. Since the A/D converter allows for approximately 20% over range on each setting an input equal to the value set at the **FNSE** setting will give a value of approximately **80.00**, the exact figure will vary between instruments due to component tolerances.

Example: **FNSE** setting = 2.5, excitation set to 10V.

For a 0mV input the **! NPE** display should be approximately **0.00**.

For a 25mV input the **! NPE** display should be approximately **80.00**.

For a 30mV input the **! NPE** display should be approximately **99.00**.

For inputs above 30mV the **! NPE** display should show “- - -”.

1.2 Output options

- 1, 3 or 6 extra relays
- Analog retransmission (single or dual analog outputs) configurable for 4–20mA., 0–1V or 0–10V. The first analog output is configurable for retransmission or PI control
- RS485 or RS232 serial communications (selectable as ASCII or Modbus RTU)
- Digital output - binary or BCD up to 16 bit, NPN or PNP output types available
- Optional outputs are available in certain combinations e.g. Extra relay plus RS232

2 Mechanical Installation

Choose a mounting position as far away as possible from sources of electrical noise such as motors, generators, fluorescent lights, high voltage cables/bus bars etc. An IP65 access cover which may be installed on the panel and surrounds is available as an option to be used when mounting the instrument in damp/dusty positions. A wall mount case is available, as an option, for situations in which panel mounting is either not available or not appropriate. A portable carry case is also available, as an option, for panel mount instruments.

Prepare a panel cut out of 45mm x 92mm +1 mm / - 0 mm (see diagram below). Insert the instrument into the cut out from the front of the panel. From the rear of the instrument fit the two mounting brackets into the recess provided (see diagram below). Whilst holding the bracket in place, tighten the securing screws being careful not to over-tighten, as this may damage the instrument. Hint: use the elastic band provided to hold the mounting bracket in place whilst tightening securing screws.

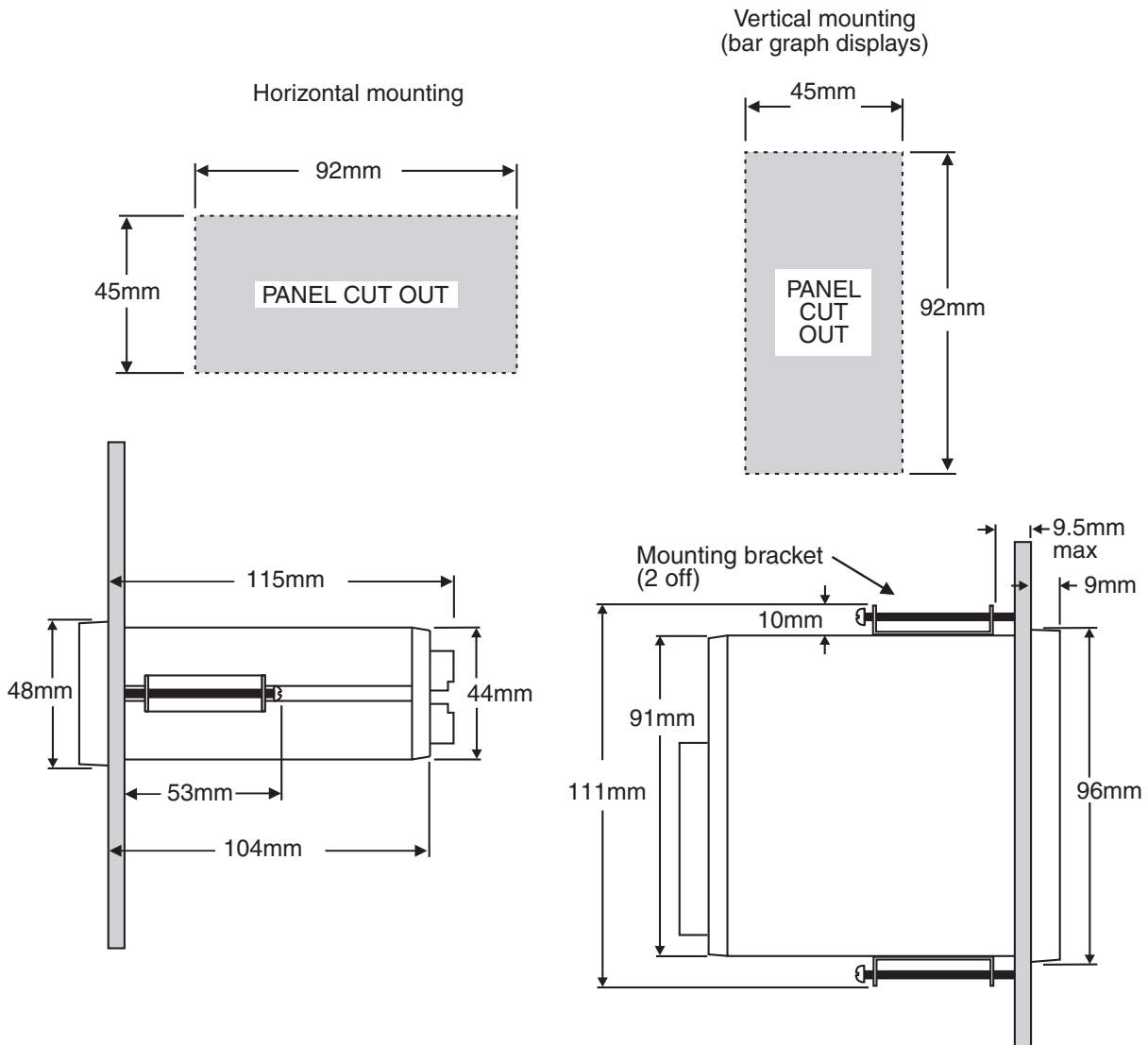

3 Electrical installation

The PM4 Panel Meter is designed for continuous operation and no power switch is fitted to the unit. It is recommended that an external switch and fuse be provided to allow the unit to be removed for servicing.

The plug in, screw type, terminal blocks allow for wires of up to 2.5mm² to be fitted. Connect the wires to the appropriate terminals as indicated below. Refer to connection details provided in this chapter to confirm proper selection of voltage, polarity and input type before applying power to the instrument.

When power is applied the instrument will cycle through a display sequence indicating the software version and other status information, this indicates that the instrument is functioning. Acknowledgement of correct operation may be obtained by applying an appropriate input to the instrument and observing the reading. The use of screened cable is recommended for signal inputs.

For connection details of optional outputs refer to the separate "PM4 Panel Meter Optional Output Addendum" booklet supplied when options are fitted.

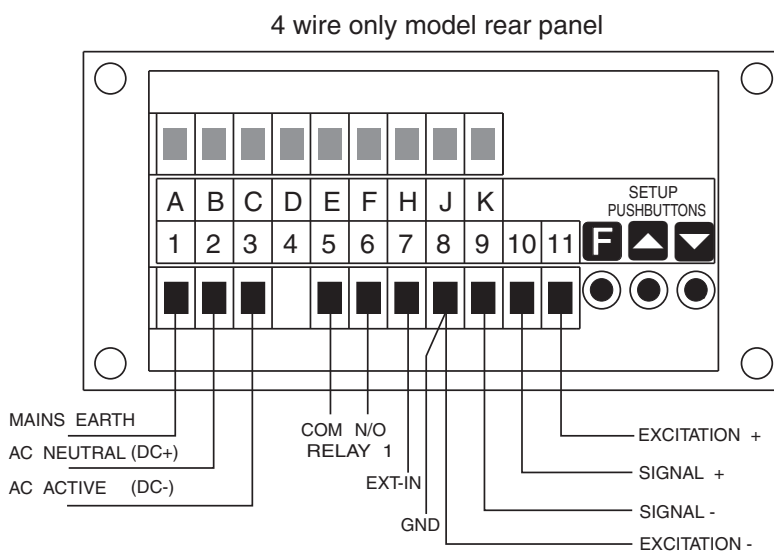
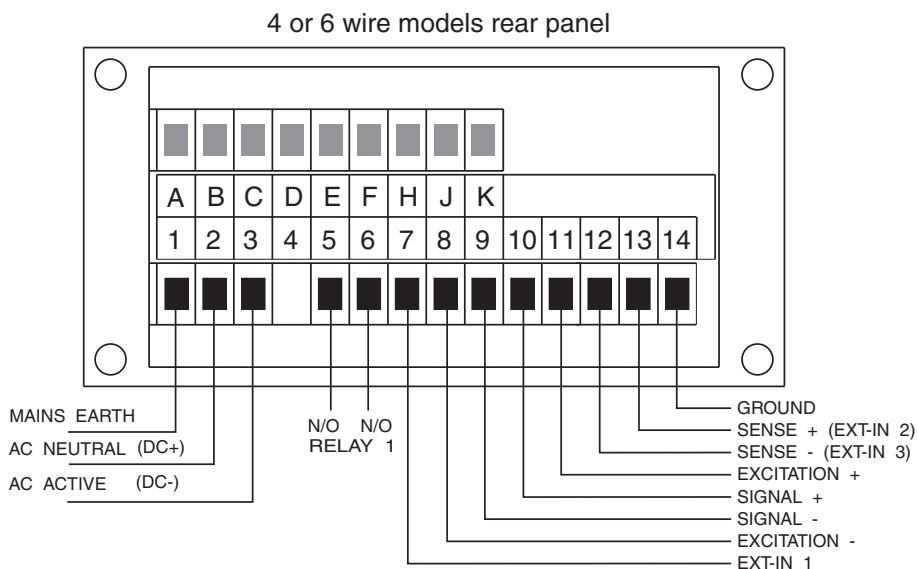

1	MAINS EARTH	
2	240VAC NEUTRAL	
3	240VAC ACTIVE	
5	RELAY 1	COM
6	RELAY 1	N/O
7	EXT IN	
8	EXCITATION -VE	-
9	SIGNAL -VE	-
10	SIGNAL	+
11	EXCITATION	+
12	REFERENCE	-
13	REFERENCE	+
14	GROUND	
PM4-WT-240-5E		SERIAL No.

Instrument data label (example)

3.1 Load cell and remote input connections

When connecting load cells in parallel (or using a low resistance bridge) use 5V excitation if the input resistance is below 350Ω e.g. if two 350Ω bridges are connected in parallel use 5V excitation. See section 3.3 for details of link settings for 4 and 6 wire load cells and excitation voltage. If pins 13 and 12 are to be used as remote inputs 2 and 3 then only 4 wire load cells may be used. Ensure that links LK1 and LK2 are set accordingly to 4 wire. Pin 8 or pin 14 may be used as the ground connection for remote inputs. Displays without front panel pushbuttons will have rear pushbuttons in place of terminals 12, 13 and 14. For 4 wire load cells use the Signal and Excitation connections.

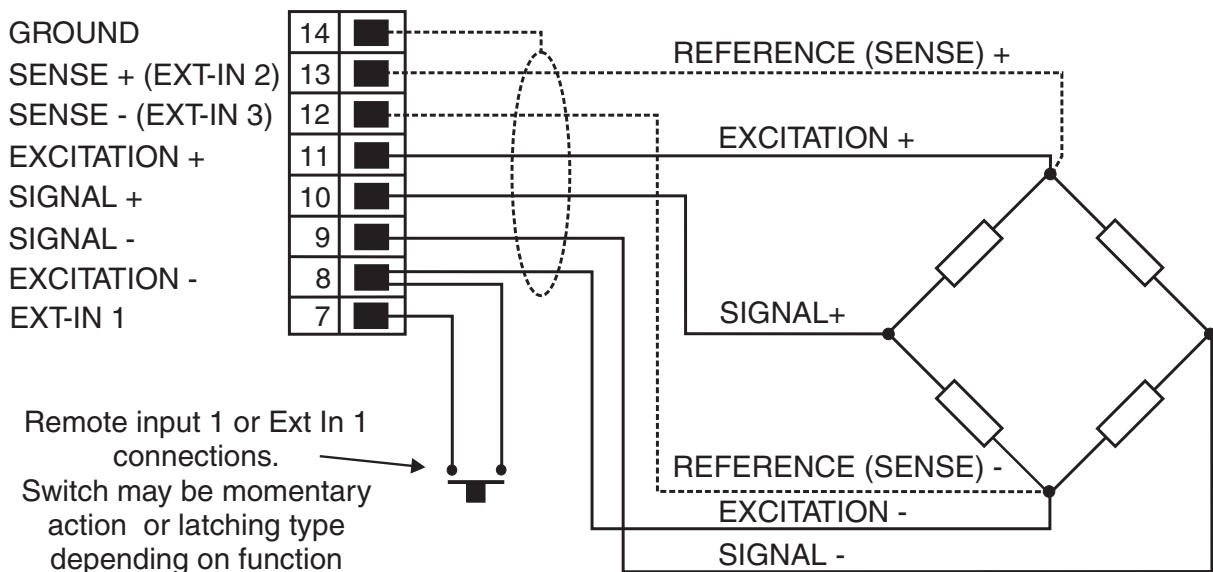

Note: Reference wires only used on 6 wire load cells

3.2 Input Output Configuration

If you need to alter the input or output configuration link settings proceed as follows:

1. Remove the plug in terminals from the rear of the instrument

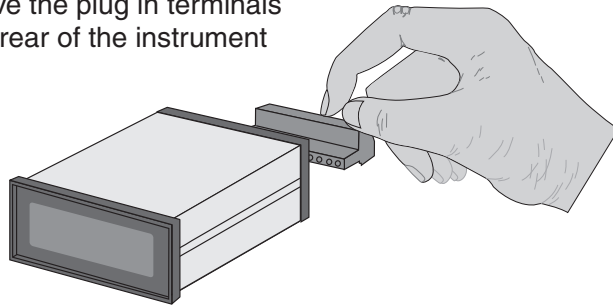

2. Remove the 4 x self tapping screws from the back cover then remove the back cover by pulling it away from the instrument

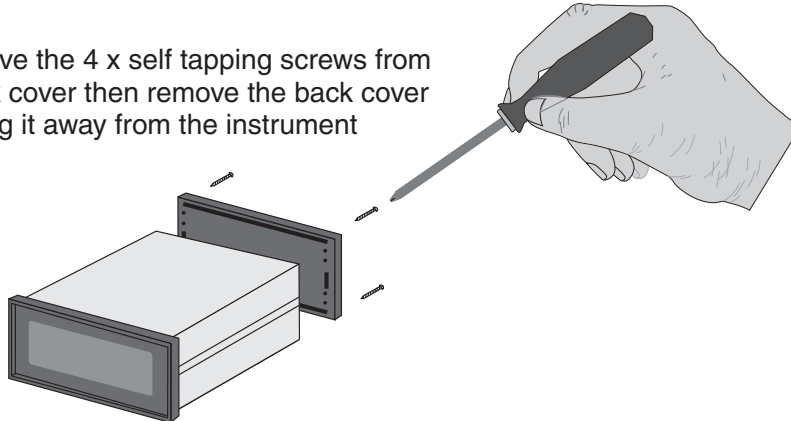

3. Remove the earth screw which passes through the underside of the case then slide out the board or boards

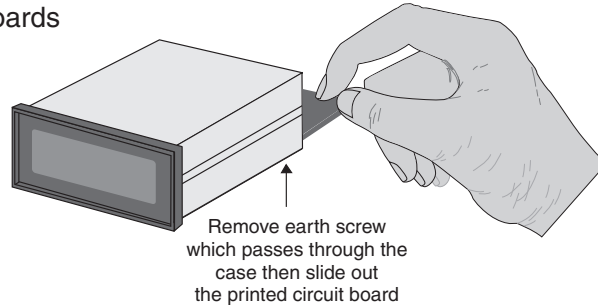

4. Configure the PCB links as required, see appropriate chapter
5. Slide PCB back into case
6. Replace the earth screw which passes through the case
7. Refit the back cover and fix with the self tapping screws
8. Plug the terminal strips back into the rear of the instrument

3.3 Input range link selection

Dismantle the instrument as described in section 3.2. Insert the links into the appropriate location on the pin header to suit the range required.

4 WIRE / 6 WIRE LINKS
 NOTE: THESE LINKS ARE NOT NEEDED ON 4 WIRE ONLY INSTRUMENTS (INSTRUMENTS WITH REAR PUSH BUTTONS) AND ARE THEREFORE NOT FITTED TO THESE INSTRUMENTS

EXCITATION VOLTAGE LINKS

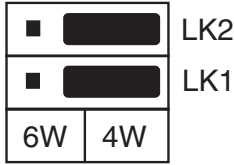

4 WIRE SELECTED



6 WIRE SELECTED

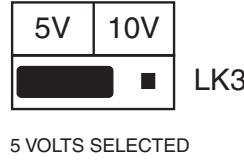

5 VOLTS SELECTED

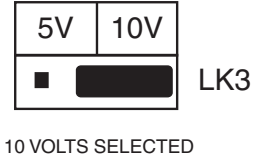

10 VOLTS SELECTED

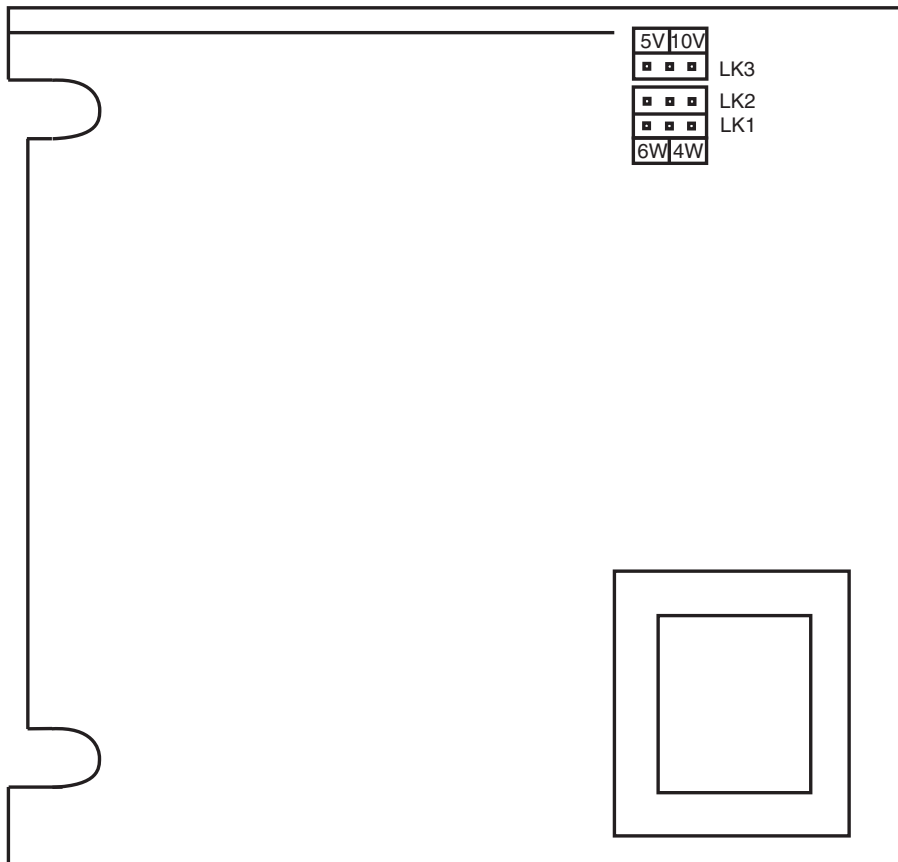

4 Function tables - summary of setup functions

Note: the order in which the functions appear on the display may vary slightly to that shown below. The availability and order of functions is determined by choice of function settings and options fitted.

Functions in this first table are available in **FUNC** or **CAL** mode

Display	Function	Range	Default	Your record	Ref/Page
RxLo	Low setpoint value for designated alarm relay <i>x</i>	Any display value or OFF	OFF	See 4.0.1	5.1 / 17
RxHi	High setpoint value for designated alarm relay <i>x</i>	Any display value or OFF	OFF	See 4.0.1	5.2 / 17
RxHY	Hysteresis value for the designated alarm relay <i>x</i> .	0 to 9999	10	See 4.0.1	5.3 / 18
Rxtt	Trip time delay for the designated alarm relay <i>x</i> .	0.0 to 999.9	0.0	See 4.0.1	5.4 / 19
Rxrt	Reset time delay for the designated alarm relay <i>x</i> .	0.0 to 999.9	0.0	See 4.0.1	5.5 / 19
Rxn.o or Rxn.c	Alarm relay <i>x</i> action to normally open (de-energised) or normally closed (energised)	Rxn.o or Rxn.c	Rxn.o	See 4.0.1	5.6 / 19
RxSP or Rxt 1 etc.	Relay operation independent setpoint or trailing setpoint (*Optional)	RxSP or Rxt 1 etc.	RxSP	See 4.0.1	5.7 / 20
brgt	Display brightness level	1 to 15	15		5.8 / 20
dull	Display remote brightness switching	0 to 15	1		5.9 / 20
bAr-	Bargraph low value (seen only on bargraph display instruments)	Any display value	0		5.10 / 21
bAr+	Bargraph high value (seen only on bargraph display instruments)	Any display value	1000		5.11 / 21
FEC-	Analog output option low display value (*Optional)	Any display value	0		5.13 / 22
FEC+	Analog output option high display value (*Optional)	Any display value	1000		5.14 / 23
FEC- Ch2	Second analog output option low display value (*Optional)	Any display value	0		5.15 / 23
FEC+ Ch2	Second analog output option high display value (*Optional)	Any display value	1000		5.16 / 23
P.SEt	Preset value	Any display value	0		5.17 / 23

(*Optional)—this function will only be accessible if the relevant option is fitted

CL.no	Calibration number selection	CAL. 1 or CAL. 2	CAL. 1		5.18 / 24
--------------	------------------------------	-----------------------------------	---------------	--	-----------

(*Optional)—this function will only be accessible if the relevant option is fitted

Functions in this second table are available only in **CAL** mode or if **ACCS** is set to **ALL**

Display	Function	Range	Default	Your record	Ref/Page
bAr tYPE	Bargraph type for instruments with bargraph display (seen only on bargraph display instruments)	bAr , S.dot , d.dot , C.bAr or r.dot	bAr		5.12 / 21
d9OP	Digital output option mode (*Optional)	bcd , b.SCL , b.n or b.n2	b.n2		5.19 / 24
d9.OP	Digital output option polarity (*Optional)	AI o or AH	AI o		5.20 / 24
bcd StAr	Digital output option BCD start position (*Optional)	0 , 1 or 2	0		5.21 / 25
d.9-	Digital output option low value (*Optional)	Any display value	0		5.22 / 25
d.9+	Digital output option high value (*Optional)	Any display value	1000		5.23 / 25
d.rnd	Display rounding	1 to 5000	1		5.24 / 25
d.CPt	Decimal point	0 , 0.1 etc.	0		5.25 / 26
F.LtR	Digital filter	0 to 8	2		5.26 / 26
rEc ctrl	Analog output PI control (*Optional)	on or OFF	OFF		5.27 / 26
rATE	Sample rate in samples/sec.	10.15.20. 30.40.50. 60.80 or 100	10		5.28 / 27
rNGE	mV/V input range	0.5.1.0.2.5. 5.0.10.25. 50 or 100	2.5		5.29 / 27

(*Optional)—this function will only be accessible if the relevant option is fitted

F.I NP	Remote input (external input) one function	NONE , P.HLd , d.HLd.H , Lo.H, Lo , tARF.ZEFO , SP.Ac.No.Ac , .CAL.S , P.SET , I.CAL , btch.CAL , O.Put or dULL	NONE		5.30 / 27
F.I N2	Remote input (external input) two function	Same as F.I NP	NONE		5.31 / 30
F.I N3	Remote input (external input) three function	Same as F.I NP	NONE		5.32 / 30
Pbut	P button function (for instruments with front P button)	NONE.H , Lo.H, Lo , tARF.ZEFO , CAL.S , P.SET.btch or O.Put	NONE		5.33 / 30
ACCS	Access mode	OFF.EASY , NONE or ALL	OFF		5.34 / 31
ABS di SP	Absolute display	on or OFF	on		5.35 / 31
SPAC	Setpoint access mode (*Optional)	A1,A1-2 etc.	A1		5.36 / 31
Lin Pts	Lineariser points, allows up to 5 calibration points	2,3,4 or 5	2		5.37 / 31
CAL 1	First live calibration point	Any display value	n/a		5.38 / 32
CAL 2	Second live calibration point	Any display value	n/a		5.39 / 32
CAL 3	Third live calibration point	Any display value	n/a		5.40 / 32
CAL 4	Fourth live calibration point	Any display value	n/a		5.41 / 32
CAL 5	Fifth live calibration point	Any display value	n/a		5.42 / 32
ECAL	mV/V entry scaling method	-19.999 to 32.000	1.000		5.43 / 33
CAL OFFSt	Calibration offset	Any display value	n/a		5.44 / 33

(*Optional)—this function will only be accessible if the relevant option is fitted

SEt ZEFO	Sets zero calibration point	Any display value	n/a		5.45 / 33
ZEFO RNGE	Zero range limit	Any display value or OFF	OFF		5.46 / 33
CAL ZEFO	Zero reference point for ZEFO RNGE operation	n/a	n/a		5.47 / 33
Auto ZEFO	Auto zero range	0 to 100	0		5.48 / 34
A.Z. cnt	Auto zero sample count	10 to 100	10		5.49 / 34
ALARM etc.	Alarm relay operation mode	L, uE, tARF, bck, P.HLd, d.HLd, Hi, Lo or di SP	L, uE	See 4.0.1	5.50 / 34
BAR	Bargraph display operation mode (*Optional)	L, uE, tARF, P.HLd, d.HLd, Hi, Lo or di SP	L, uE		5.51 / 35
REC or D9.OP or SEFL	Analog/digital/serial operation mode (*Optional)	L, uE, tARF, bck, P.HLd, d.HLd, Hi, Lo or di SP	L, uE		5.52 / 36
Lo di SP	Low overrange visual warning limit value	Any display value or OFF	OFF		5.53 / 37
Hi SH di SP	High overrange visual warning limit value	Any display value or OFF	OFF		5.54 / 37
di SP	Display visual warning flashing mode	FLSH or -or-	FLSH		5.55 / 38
BAUD RATE	Baud rate for serial communications (*Optional)	300.600.1200.2400.4800.9600.19.2 or 38.4	9600		5.56 / 38
Prty	Parity for serial communications (*Optional)	NONE.EVEN or odd	NONE		5.57 / 38
Output	Output for serial communications (*Optional)	di SP, Cont, POLL, R.buS or ā.buS	Cont		5.58 / 38
Addr	Instrument address for serial communications (*Optional)	0 to 31	0		5.59 / 39

(*Optional)—this function will only be accessible if the relevant option is fitted

SEFL	Serial mode for serial communications (*Optional)	L, UE. tAFE . P.HLd. d.HLd.H, . Lo.H, Lo or di SP	L, UE		5.60 / 39
-------------	---------------------------------------------------	--------------------------------------------------------------------------	--------------	--	-----------

(*Optional)—this function will only be accessible if the relevant option is fitted

4.0.1 Relay table

Record your relay settings in the table below

Display	Relay 1	Relay 2	Relay 3	Relay 4	Relay 5	Relay 6	Relay 7
AxLo							
AxH,							
AxHY							
Axtt							
Axrt							
Axn.o or Axn.c							
AxSP or Axt 1 etc.	n/a						
A 1.A2 etc.							

5 Explanation of functions

The PM4 setup and calibration functions are configured through a push button sequence. The three push buttons located at the rear of the instrument (also at the front on some display options) are used to alter settings. Two basic access modes are available:

FUNC mode (simple push button sequence) allows access to commonly set up functions such as alarm setpoints.

CAL mode (power up sequence plus push button sequence) allows access to all functions including calibration parameters.

Once **CAL** or **FUNC** mode has been entered you can step through the functions, by pressing and releasing the **F** push button, until the required function is reached. Changes to functions are made by pressing the or push button (in some cases both simultaneously) when the required function is reached. See the flow chart example on the following page.

Entering **CAL** Mode



1. Remove power from the instrument. Hold in the **F** button and reapply power. The display will briefly indicate **CAL** as part of the "wake up messages" when the **CAL** message is seen you can release the button. Move to step 2 below.



2. When the "wake up" messages have finished and the display has settled down to its normal reading press, then release the **F** button. Move to step 3 below.

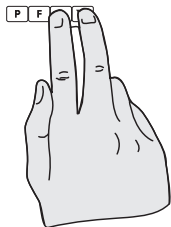

3. Within 2 seconds of releasing the **F** button press, then release the **▲** and **▼** buttons together. The display will now indicate **FUNC** followed by the first function.

Note: If step 1 above has been completed then the instrument will remain in this **CAL** mode state until power is removed. i.e. there is no need to repeat step 1 when accessing function unless power has been removed.

Entering **FUNC** Mode

No special power up procedure is required to enter **FUNC** mode.



1. When the "wake up" messages have finished and the display has settled down to its normal reading press, then release the **F** button.

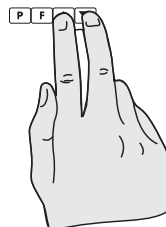

2. Within 2 seconds of releasing the **F** button press, then release the **▲** and **▼** buttons together. The display will now indicate **FUNC** followed by the first function.

Example: Entering **FUNC** mode to change alarm 1 high function **A 1H**, from **OFF** to **100**

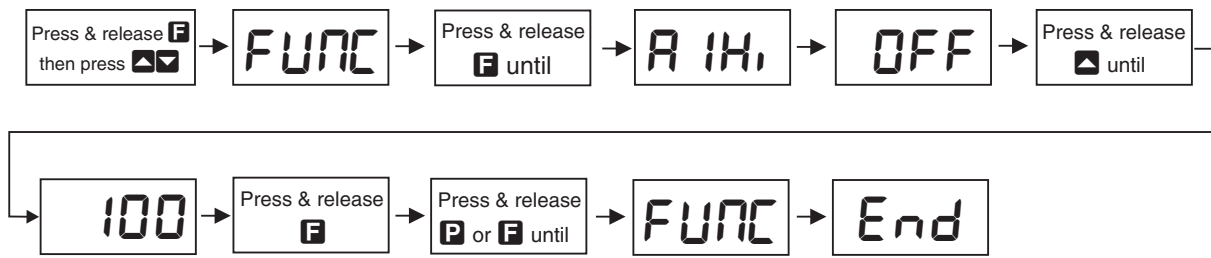

Example: Entering **CAL** mode to change decimal point function **dCpT** from **0** to **0.02**

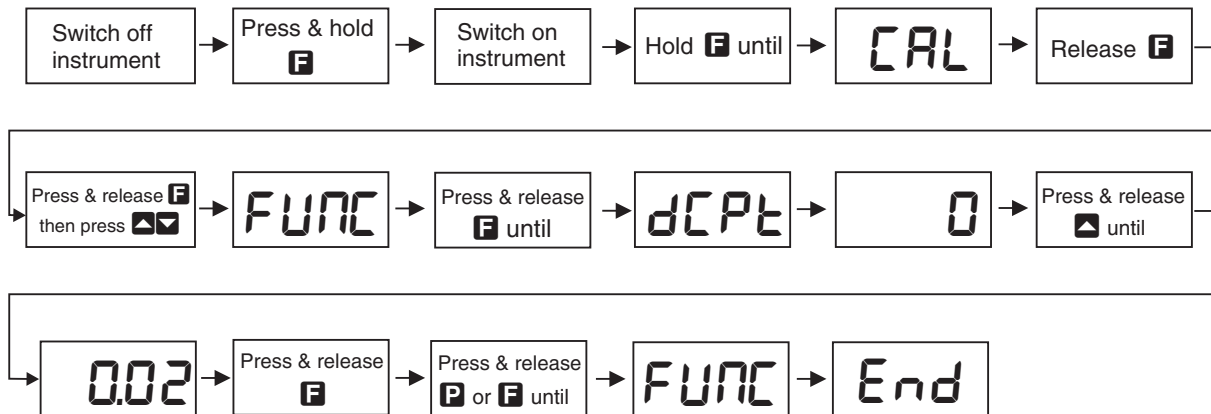

Easy alarm relay adjustment access facility

The display has an easy alarm access facility which allows access to the alarm setpoints simply by pressing the **F** button at the front or rear of the instrument. The first setpoint will then appear and changes to this setpoint may be made to this setpoint via the **▲** or **▼** buttons. Press the **F** button to accept any changes or to move on to the next setpoint. Note: this easy access also functions in the same manner for the PI control setpoint (relay and/or analog PI output) if PI control is available. The instrument must be set in the manner described below to allow the easy access facility to work:

1. A remote input function such as **F.I NP** function must be set to **SPAC** or the **ACCS** function must be set to **EASY**.
2. At least one alarm must have a setpoint, nothing will happen if all the alarm setpoints are set to **OFF**.
3. The **SPAC** function must be set to allow access to the relays required e.g. if set to **A 1-2** then the easy access will work only with alarm relays 1 and 2 even if more relays are fitted.
4. The instrument must be in normal measure mode i.e. if the instrument is powered up so that it is in **CAL** mode then the easy access will not function. If in doubt remove power from the instrument, wait for a few seconds then apply power again.
5. If the easy access facility is used then the only way to view or alter any other function settings is to power up via **CAL** mode i.e. there is no entry to **FUNC** mode functions unless the instrument is powered up in **CAL** mode.

Explanation of Functions

5.1 Alarm relay low setpoint

- Display:** $RxLo$
- Range:** Any display value or **OFF**
- Default Value:** **OFF**

Displays and sets the low setpoint value for the designated alarm relay x . Note x will be replaced by the relay number when displayed e.g. $R1Lo$ for relay 1. Use this low setpoint function if a relay operation is required when the display value becomes equal to or less than the low setpoint value. To set a low alarm value go to the $RxLo$ function and use the \blacktriangle or \blacktriangledown push buttons to set the value required then press **F** to accept this value. The low alarm setpoint may be disabled by pressing the \blacktriangle and \blacktriangledown push buttons simultaneously. When the alarm is disabled the display will indicate **OFF**. If the relay is allocated both a low and high setpoint then the relay will activate when the value displayed moves outside the band set by the low and high setpoints. The value at which the relay will reset is controlled by the $RxHy$ function.

Example:

If $R1Lo$ is set to **10** then relay 1 will activate when the display value is 10 or less.

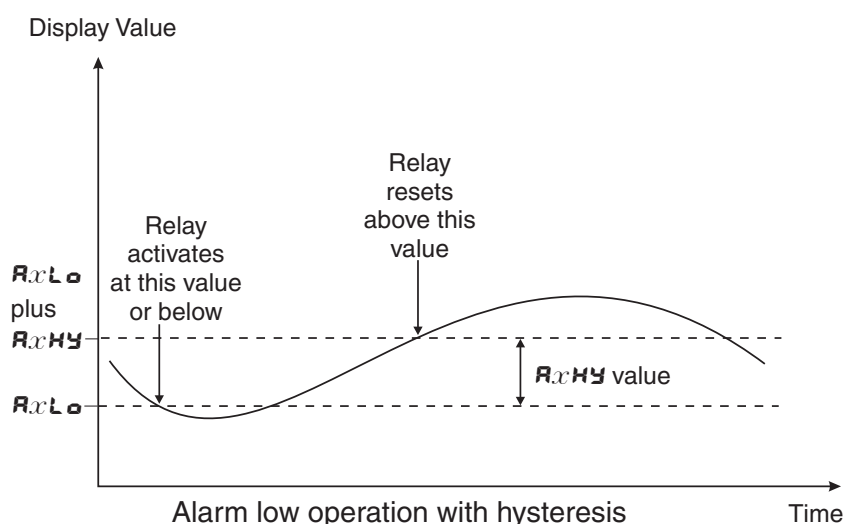

5.2 Alarm relay high setpoint

- Display:** RxH
- Range:** Any display value or **OFF**
- Default Value:** **OFF**

Displays and sets the high setpoint value for the designated alarm relay x . Note x will be replaced by the relay number when displayed e.g. $R1H$ for relay 1. Use this high setpoint function if a relay operation is required when the display value becomes equal to or more than the low setpoint value. To set a high alarm value go to the RxH function and use the \blacktriangle or \blacktriangledown push buttons to set the value required then press **F** to accept this value. The high alarm setpoint may be disabled by pressing the \blacktriangle and \blacktriangledown push buttons simultaneously. When the alarm is disabled the display will indicate **OFF**. If the relay is allocated both a low and high setpoint then the relay will activate when the value displayed moves outside the band set by the low and high setpoints. The value at which the relay will reset is controlled by the $RxHy$ function.

Example:

If **R 1H** is set to **100** then relay 1 will activate when the display value is **100** or higher.

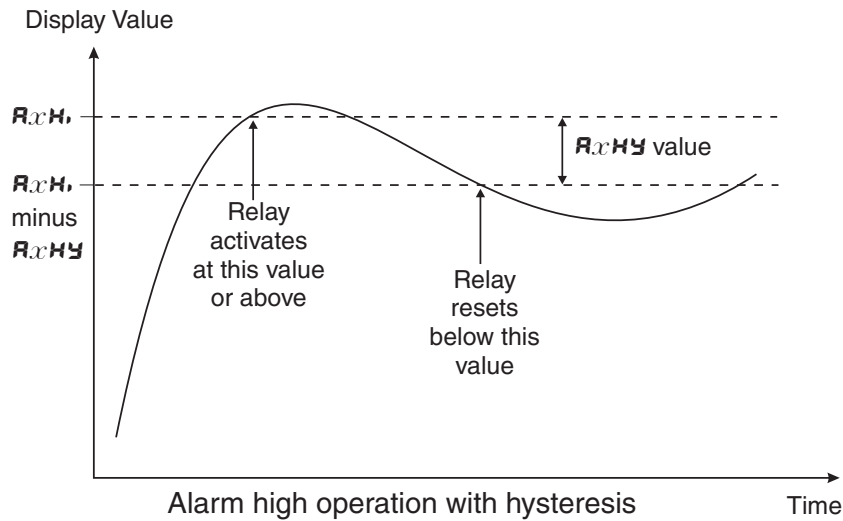

5.3 Alarm relay hysteresis (deadband)

Display: **R xHY**
Range: **0** to **9999**
Default Value: **10**



Displays and sets the alarm relay hysteresis limit for the designated relay *x*. Note *x* will be replaced by the relay number when displayed e.g. **R 1HY** for relay 1. To set a relay hysteresis value go to the **R xHY** function and use the **▲** or **▼** push buttons to set the value required then press **F** to accept this value. The hysteresis value is common to both high and low setpoint values. The hysteresis value may be used to prevent too frequent operation of the relay when the measured value is rising and falling around setpoint value. e.g. if **R 1HY** is set to zero the alarm will activate when the display value reaches the alarm setpoint (for high alarm) and will reset when the display value falls below the setpoint, this can result in repeated on/off switching of the relay at around the setpoint value.

The hysteresis setting operates as follows: In the high alarm mode, once the alarm is activated the input must fall below the setpoint value minus the hysteresis value to reset the alarm. e.g. if **R 1H** is to **50.0** and **R 1HY** is set to **3.0** then the setpoint output relay will activate once the display value goes to **50.0** or above and will reset when the display value goes below **47.0** i.e. at **46.9** or below. In the low alarm mode, once the alarm is activated the input must rise above the setpoint value plus the hysteresis value to reset the alarm. e.g. if **R 1Lo** is to **20.0** and **R 1HY** is set to **10.0** then the alarm output relay will activate when the display value falls to **20.0** or below and will reset when the display value goes above **30.0** i.e. at **30.1** or above. The hysteresis units are expressed in displayed engineering units.

Example: If **R 1H** is set to **100** and **R 1HY** is set to **10** then relay 1 will activate when the display value is **100** or higher and will reset at a display value of **89** or lower.

5.4 Alarm relay trip time



Display: **Axtt**
Range: **0.0** to **999.9**
Default Value: **0.0**

Displays and sets the alarm trip time in seconds and tenths of seconds. The trip time is common for both alarm high and low setpoint values. The trip time provides a time delay before the alarm relay will activate when an alarm condition is present. The alarm condition must be present continuously for the whole trip time period before the alarm will activate. If the input moves out of alarm condition during this period the timer will reset and the full time delay will be restored. This trip time delay is useful for preventing an alarm trip due to short non critical deviations from setpoint. The trip time is selectable over **0.0** to **999.9** seconds. To set a trip time value go to the **Axtt** function and use the  or  push buttons to set the value required then press  to accept this value.

Example: If **A1tt** is set to **5.0** seconds then the display must indicate an alarm value for a full 5 seconds before relay 1 will activate.

5.5 Alarm relay reset time



Display: **Axrt**
Range: **0.0** to **999.9**
Default Value: **0.0**

Displays and sets the alarm reset delay time in seconds and tenths of seconds. The reset time is common for both alarm high and low setpoint values. With the alarm condition is removed the alarm relay will stay in its alarm condition for the time selected as the reset time. If the input moves back into alarm condition during this period the timer will reset and the full time delay will be restored. The reset time is selectable over **0.0** to **9999.9** seconds. To set a reset time value go to the **Axrt** function and use the  or  push buttons to set the value required then press  to accept this value.

Example: If **A1rt** is set to **10.0** seconds then the resetting of alarm relay 1 will be delayed by 10 seconds.

5.6 Alarm relay normally open/closed

Display: **Axn.o** or **Axn.c**
Range: **Axn.o** or **Axn.c**
Default Value: **Axn.o**

Displays and sets the setpoint alarm relay *x* action to normally open (de-energised) or normally closed (energised), when no alarm condition is present. Since the relay will always open when power is removed a normally closed alarm is often used to provide a power failure alarm indication. To set the alarm relay for normally open or closed go to the **Axn.o** or **Axn.c** function and use the  or  push buttons to set the required operation then press  to accept this selection. **Example:** If set to **A1n.o** alarm relay 1 will be open circuit when the display is outside alarm condition and will be closed (short circuit across terminals) when the display is in alarm condition.

5.7 Alarm relay setpoint or trailing operation

Display: **RxSP** or **Rxt I** etc.

Range: **RxSP** or **Rxt I** etc.

Default Value: **RxSP**

Relay operation independent setpoint or trailing setpoint, this function will not be seen unless extra optional relays are fitted. Each alarm relay, except relay 1, may be programmed to operate with an independent setpoint value or may be linked to operate at a fixed difference to another relay setpoint, known as trailing operation. The operation is as follows:

Alarm 1 (**R1**) is always independent. Alarm 2 (**R2**) may be independent or may be linked to Alarm 1. Alarm 3 (**R3**) may be independent or may be linked to Alarm 1 or Alarm 2. Alarm 4 (**R4**) may be independent or may be linked to Alarm 1, Alarm 2 or Alarm 3. The operation of each alarm is selectable by selecting, for example, (Alarm 4) **R4.SP** = Alarm 4 normal setpoint or **R4.t I** = Alarm 4 trailing Alarm 1 or **R4.t 2** = Alarm 4 trailing Alarm 2 or **R4.t 3** = Alarm 4 trailing Alarm 3. For trailing set points the setpoint value is entered as the difference from the setpoint being trailed. If the trailing setpoint is to operate ahead of the prime setpoint then the value is entered as a positive number and if operating behind the prime setpoint then the value is entered as a negative number.

Example: With Alarm 2 set to trail alarm 1, if **R1H** is set to **1000** and **R2H** is set to **50** then Alarm 1 will activate at **1000** and alarm 2 will activate at **1050** (i.e. 1000 + 50). If Alarm 2 had been set at **-50** then alarm 2 would activate at **950** (i.e. 1000 - 50).

5.8 Display brightness

Display: **brgt**

Range: **1** to **15**

Default Value: **15**

Displays and sets the digital display brightness. The display brightness is selectable from **1** to **15**, where **1** = lowest intensity and **15** = highest intensity. This function is useful for improving the display readability in dark areas or to reduce the power consumption of the instrument. See also the **dull** function. To set brightness level go to the **brgt** function and use the **▲** or **▼** push buttons to set the value required then press **F** to accept this value.

5.9 Display remote brightness switching

Display: **dull**

Range: **0** to **15**

Default Value: **1**

Displays and sets the level for remote input brightness switching, see **r.i NP** function. When a remote input is set to **dull** the remote input can be used to switch between the display brightness level set by the **brgt** function 5.8 and the display brightness set by the **dull** function. The display dull level is selectable from **0** to **15**, where **0** = lowest intensity and **15** = highest intensity. This function is useful in reducing glare when the display needs to be viewed in both light and dark ambient light levels. To set dull level go to the **dull** function and use the **▲** or **▼** push buttons to set the value required then press **F** to accept this value.

Example: With **dull** set to **4** and **bright** set to **15** and the **FUNC** function set to **dull** the display brightness will change from the **15** level to **4** when a switch connected to the remote input terminals is activated.

5.10 Bargraph low value

Display: **bAr_**
Range: Any display value
Default Value: **0**

Seen only in bargraph display instruments. Displays and sets the bar graph low value i.e. the value on the 7 segment display at which the bargraph will start to rise. This may be independently set anywhere within the display range of the instrument. Note: The **bAr_** and **bAr^** settings are referenced from the 7 segment display readings, not the bargraph scale values. The bargraph scale may scaled differently to the 7 segment display. For example the bargraph scale may be indicating percentage fill of a tank whilst the 7 segment display is indicating actual process units. To set bargraph low level go to the **bAr_** function and use the **▲** or **▼** push buttons to set the value required then press **F** to accept this value.

5.11 Bargraph high value

Display: **bAr^**
Range: Any display value
Default Value: **1000**

Seen only in bargraph display instruments. Displays and sets the bar graph high value i.e. the value on the 7 segment display at which the bargraph will reach its maximum indication (e.g. all LEDs illuminated). May be independently set anywhere within the display range of the instrument. To set bargraph high level go to the **bAr^** function and use the **▲** or **▼** push buttons to set the value required then press **F** to accept this value.

5.12 Bargraph type for instruments with bargraph display

Display: **bAr TYPE**
Range: **bAr**, **S.dot**, **d.dot**, **C.bAr** or **r.dot**
Default Value: **bAr**

Bar graph display operation mode - seen only in vertical or circular bargraph display instruments. Allows selection of bargraph operation mode. Choices available are:



- **bAr** - conventional solid bargraph display i.e. all LEDs illuminated when at full scale. When scaling the display use the **bAr_** and **bAr^** functions e.g. **bAr_ = 0** and **bAr^ = 100** will give a bargraph with no segments lit at a 7 segment display reading of **0** and all segments lit with a 7 segment display reading of **100**.
- **S.dot** - single dot display. A single segment will be lit to indicate the input readings position on the scale. When scaling the display use the **bAr_** and **bAr^** functions e.g. **bAr_ = 0** and **bAr^ = 100** will give a bargraph with the bottom segment lit at a 7 segment display reading of **0** and the top segment lit with a 7 segment display reading of **100**. Note:



this could also be set up as a centre zero single dot display by entering a negative value and positive value. e.g. $bAr_{-} = -100$, $bAr_{+} = 100$.

- **d.dot** - double dot display. Two segments will be lit to indicate the input reading position on the scale. The reading should be taken from the middle of the two segments. When scaling the display use the bAr_{-} and bAr_{+} functions e.g. $bAr_{-} = 0$ and $bAr_{+} = 100$ will give a bargraph with the bottom two segments lit at a 7 segment display reading of **0** and the top two segments lit with a 7 segment display reading of **100**. Note: this could also be set up as a centre zero double dot display by entering a negative value and positive value. e.g. $bAr_{-} = -100$, $bAr_{+} = 100$.
- **C.bAr** - centre bar display. The display will be a solid bargraph but will have its zero point in the middle of the display. If the seven segment display value is positive the bargraph will rise. If the seven segment display value is negative then the bargraph will fall. When scaling the display use the bAr_{-} and bAr_{+} functions e.g. $bAr_{-} = 0$ and $bAr_{+} = 100$ will give a bargraph with all the bottom half segments lit at a 7 segment display reading of **-100** and all the top segments lit with a 7 segment display reading of **100**.
- **r.dot** - modulus or wrap around single dot bargraph. This mode of operation allows the bargraph to wrap around the limits set by the bAr_{-} and bAr_{+} functions by dividing the 7 segment display by the modulus (the modulus is the difference between 0 and bAr_{+}) and displaying the remainder. For example if bAr_{-} is set to **0** and bAr_{+} is set to **10** then in other bargraph modes when the 7 segment display reads a value such as **25** the bargraph would be stuck at the high limit of its travel since it cannot go beyond **10**. In **r.dot** mode the display will wrap around at **10** then continue up the bar again and will be at the midpoint of the bargraph when the 7 segment display shows **25** (as it would for a 7 segment display of **15**, **35**, etc.). In this example for a 7 segment display of **25** the value of 25 is divided by the modulus value of 10 in this example and the remainder displayed i.e. 10 goes into 25 twice with the remainder of 5 and so a bargraph position of 5 is displayed. This mode will operate on both vertical and circular bargraph type displays.

5.13 Analog output option low value

Display: rEC_{-}
Range: Any display value
Default Value: **0**

Seen only when analog retransmission option fitted. Refer to the separate “PM4 Panel Meter Optional Output Addendum” booklet supplied when this option is fitted for wiring details and link settings. Displays and sets the analog retransmission (4–20mA, 0–1V or 0–10V, link selectable) output low value (4mA or 0V) in displayed engineering units. To set the analog output low value go to the rEC_{-} function and use the  or  push buttons to set the required value then press  to accept this selection.

Example: If it is required to retransmit 4mA when the display indicates **0** then select **0** in this function using the  or  button.

5.14 Analog output option high value

Display: **FEE⁻**
Range: Any display value
Default Value: **1000**

Seen only when analog retransmission option fitted. Refer to the separate “PM4 Panel Meter Optional Output Addendum” booklet supplied when this option is fitted for wiring details and link settings. Displays and sets the analog retransmission (4–20mA, 0–1V or 0–10V, link selectable) output high display value (20mA, 1V or 10V) in displayed engineering units. To set the analog output high value go to the **FEE⁻** function and use the **▲** or **▼** push buttons to set the required value then press **F** to accept this selection.

Example: If it is required to retransmit 20mA when the display indicates **50** then select **50** in this function using the **▲** or **▼** button.

5.15 Second analog output option low value

Display: **FEE⁻ CH2**
Range: Any display value
Default Value: **0**

See **FEE⁻** function 5.13 for description of operation.

5.16 Second analog output option high value

Display: **FEE⁻ CH2**
Range: Any display value
Default Value: **1000**

See **FEE⁻** function 5.14 for description of operation.

5.17 Preset value

Display: **P.SET**
Range: Any display value
Default Value: **0**

A preset value can be entered at this function. If a remote input (**FINP** function) or **P** button (**P.but** function) is programmed to **P.SET** then operation of the remote input or **P** button will cause the display to change to the preset value. Any change in input from this point will cause a variation above or below the preset value. To set preset value go to the **P.SET** function and use the **▲** or **▼** push buttons to set the value required then press **F** to accept this value. **Example:** With a display showing a value of **50** at a given input if the **P.SET** function is set to **70** and the remote function is set to **P.SET** then once the remote input is activated the same input will now have a display value of **70**.

5.18 Calibration number

Display: **CL.no**
Range: **CAL. 1** or **CAL.2**
Default Value: **CAL. 1**

Cell or channel number selection - selects one of the two possible calibration settings (**CAL. 1** or **CAL.2**). This function allows the instrument to be calibrated to two different load cells and hold the calibration values in memory. Alternatively two different calibration scaling values may be entered for a single cell. The user may select the load cell to be used via this **CL.no** function or alternatively via the **P** button (if display has a **P** button, and **Pbut** function 5.33 is set to **CAL.5**) or via a remote input (see **CAL.5** function. To scale any of these independent calibration memories you may use any of the methods described in the Chapter 6. Simply select the required cell number then scale using whichever calibration method best suits the application. If a remote input or **P** button is used to select the channel then do not use the **CL.no** function to select the channel i.e. only use one method of selecting the channel. In addition to different scaling the two channels can be set to operate from different decimal point (**dCPE**), sample rate (**FRE**), mV/V range (**RNGE**), lineariser points (**L, n Pts**, low and high overrange (**Lo di SP** and **Hi 9H di SP**), display warning type (**di SP**) and zero range **ZERO RNGE** settings. If using this function in conjunction with the remote inputs or **P** button functions then the peak hold, display hold, peak and valley memory, zero, remote input calibrate, and serial print output functions will operate individually for each channel, the tare command will tare both channels simultaneously. Other remote input and **P** button functions are not intended for use with the channel selection function.

5.19 Digital output option mode

Display: **d9DP**
Range: **bcd**, **b.5CL**, **b, n** or **b, n2**
Default Value: **b, n2**

Seen only with the 16 bit digital output option. Refer to the separate “PM4 Panel Meter Optional Output Addendum” booklet supplied when this option is fitted. Selections available are: **b, n2** (signed binary) i.e. -32767 to 32767, **b, n** (unsigned binary) i.e. 0 to 65535, **b.5CL** (scaled binary, see **d, 9-** and **d, 9+** below), **bcd** (binary coded decimal) i.e. up to four BCD numbers. .

5.20 Digital output option polarity

Display: **d9.OP**
Range: **AI o** or **AH,**
Default Value: **AI o**

Seen only with the 16 bit digital output option. Refer to the separate “PM4 Panel Meter Optional Output Addendum” booklet supplied when this option is fitted. Selections available are: **AI o** (active low i.e. logic 1 = 0V output, logic 0 = +V output) or **AH,** (active high i.e. logic 1 = +V output, logic 0 = 0V output).

5.21 Digital output option BCD start position

Display: `bcd Start`
Range: `0, 1` or `2`
Default Value: `0`

Seen only with the 16 bit digital output option. Refer to the separate “PM4 Panel Meter Optional Output Addendum” booklet supplied when this option is fitted. This function affects BCD mode only and determines the number of digits to skip when outputting from the display. As the output is 16 bit it can output up to 4 BCD numbers. Select from `0` to number of display digits minus 4. e.g. for a 6 digit display you may select `0` to `2`, if `2` is selected then the four left most digits will be output, if set to `0` then the four right most digits will be output.

5.22 Digital output option low value

Display: `d, 9-`
Range: Any display value
Default Value: `0`

Seen only with the 16 bit digital output option. Refer to the separate “PM4 Panel Meter Optional Output Addendum” booklet supplied when this option is fitted. Accepts any valid display value. Determines the low scaling point for the `b.SCL` mode and has no effect on other modes. See example which follows in 5.23.

5.23 Digital output option high value

Display: `d, 9^`
Range: Any display value
Default Value: `1000`

Seen only with the 16 bit digital output option. Refer to the separate “PM4 Panel Meter Optional Output Addendum” booklet supplied when this option is fitted. Determines the high scaling point for the `b.SCL` mode and has no effect on other modes.

Example: If `d, 9-` is set to `0` and `d, 9^` is set to `65535` ($2^{16} - 1$) then the retransmission will not be scaled i.e. a display of `2` will cause a retransmission of 2. If `d, 9^` is now changed to `32767` ($2^{15} - 1$) then a display of `2` will cause a retransmission of 4 (note: rounding may occur on retransmission).

5.24 Display rounding

Display: `drnd`
Range: `1` to `5000`
Default Value: `1`

Displays and sets the display rounding value. This value may be set to 1 - 5000 displayed units. Display rounding is useful for reducing the instrument resolution without loss of accuracy in applications where it is undesirable to display to a fine tolerance. To set the display rounding value

go to the **drnd** function and use the **▲** or **▼** push buttons to set the required value then press **F** to accept this selection.

Example: If set to **10** the display values will change in multiples of 10 only i.e. display moves from **10** to **20** to **30** etc.

5.25 Decimal point

Display: **dCPE**
Range: **0, 0.1** etc.
Default Value: **0**

Displays and sets the decimal point. By pressing the **▲** or **▼** pushbutton at the **dCPE** function the decimal point position may be set. The display will indicate as follows: **0** (no decimal point), **0.1** (1 decimal place), **0.02** (2 decimal places), **0.003** (3 decimal places) and **0.0004** for display with more than 4 digits. Note if the decimal point is altered the display will need to be recalibrated and alarm etc. settings checked.

5.26 Digital filter

Display: **FLtr**
Range: **0** to **8**
Default Value: **2**

Displays and sets the digital filter value. Digital filtering uses a weighted average method of determining the display value and is used for reducing display value variation due to short term interference. The digital filter range is selectable from **0** to **8**, where **0** = none and **8** = most filtering. Use **▲** or **▼** at the **FLtr** function to alter the filter level if required. Note that the higher the filter setting the longer the display may take to reach its final value when the input is changed, similarly the relay operation and any output options will be slowed down when the filter setting is increased. To set the digital filter value go to the **FLtr** function and use the **▲** or **▼** push buttons to set the required value then press **F** to accept this selection.

5.27 Analog output PI control

Display: **rEc ctrl**
Range: **on** or **OFF**
Default Value: **OFF**

Analog output mode - seen only when analog output option is fitted. This function allows selection of **on** or **OFF** for PI control analog output. If set to **OFF** the analog output operates as a retransmission output and uses the functions described in this chapter. If set to **on** the analog output operates as a PI control output.

When this function is set to **on** the following associated functions will appear: **C.SET**, **C.SPn**, **C.P9**, **C.Po**, **C.I9**, **C.I.H**, **C.I.L** and **REC SPAC**. These functions are not detailed in this manual. Refer to the separate "PM4 Panel Meter Optional Output Addendum" booklet for description of the analog PI control functions and wiring details.

5.28 Sample rate

Display: **FRtE**
Range: **10 . 15 . 20 . 30 . 40 . 50 . 60 . 80** or **100**
Default Value: **10**

Displays and sets the input sample rate from 10 to 100 samples per second. Note: the display updates approx. 4 times per second. The faster sample rates can be utilised in features such as peak hold, peak/valley memory, analog or digital retransmission and serial communications.

5.29 mV/V input range

Display: **FRGE**
Range: **0.5 . 1.0 . 2.5 . 5.0 . 10 . 25 . 50** or **100**
Default Value: **2.5**

Displays and sets the mV/V (milli Volt output per Volt of excitation) range to suit the transducer useable range. For example a transducer with 2mV/V output will have a theoretical output from 0mV at no load to 20mV at full specified load if 10V excitation is used. Check the transducer label or transducer calibration sheet or brochure for mV/V specification. Choose the value equal to or the next higher value to the mV/V output of the transducer. This selection sets the input range for the A/D converter. If too low a range is selected a “- - - -” error message may be seen on the display when a load is applied. If too high a range is selected the full resolution capability will not be used and problems with calibration can result - see “Error messages” section.

5.30 Remote input function

Display: **FRIP**
Range: **NONE . P.HLd . d.HLd . Hi . Lo . Hi . Lo . tRGE . 2EFD . SP.Ac . No.Ac .**
CAL.S . P.SET . I . CAL . btch . CAL , . O.Put or **dULL**
Default Value: **NONE**

Remote input function - When these remote input terminals are short circuited, via a switch, relay, keyswitch etc. the instrument will perform the selected remote input function. A message will flash to indicate which function has been selected when the remote input pins are short circuited. The remote input functions are as follows:

NONE - no remote function required i.e. activating the remote input has no effect.

P.HLd - peak hold. The display will show the peak value (highest positive value) only whilst the remote input terminals are short circuited i.e. the display value can rise but not fall whilst the input terminals are short circuited. The message **P.HLd** will appear briefly every 8 seconds whilst the input terminals are short circuited to indicate that the peak hold function is active.

d.HLd - display hold. The display value will be held whilst the remote input terminals are short circuited. The message **d.HLd** will appear briefly every 8 seconds whilst the input terminals are short circuited to indicate that the display hold function is active.

Hi - peak memory. The peak value stored in memory will be displayed if the remote input terminals are short circuited, if the short circuit is momentary then the display will return

to normal measurement after 20 seconds. If the short circuit is held for 2 to 3 seconds or the power is removed from the instrument then the memory will be reset.

Lo - valley memory. The minimum value stored in memory will be displayed. Otherwise operates in the same manner as the **H**, function described above.

H, Lo - toggle between **H**, and **Lo** displays. This function allows the remote input to be used to toggle between peak and valley memory displays. The first operation of the remote input will cause the peak memory value to be displayed, the next operation will give a valley memory display. **PH**, or **PLo** will flash before each display to give an indication of display type.

TARE - display tare. Short circuiting the remote input pins momentarily will allow toggling between nett and gross values (shown as **NETT** and **GROSS**). If the remote input is short circuited for approx. 2 seconds the display will be tared and will show zero. The tare will be lost if power is removed.

ZERO - display zero. Zeroes the display in same manner as the tare function except that the zero is not lost when power is removed and the display will zero as soon as the remote input is shorted. When the **ZERO** operation is used the gross value cannot be recalled and the input at the time of the **ZERO** operation will become the new zero point.

SP.Ac - setpoint access only. This blocks access to any functions except the alarm setpoint functions unless the remote input pins are short circuited or entry is made via **CAL** mode or if the **ACCS** function is set to **ALL**.

No.Ac - no access. This blocks access to all functions unless the remote input pins are short circuited or entry is made via **CAL** mode or if the **ACCS** function is set to **ALL**.

CAL.S - calibration select. The remote input can be used to select between calibration scaling values. Two sets of calibration scalings can be entered in the display, one set with the remote input terminals open circuit and another set with the remote input terminals short circuit to ground. The remote input can then be used to switch between one set and the other. This allows two different load cells to be connected with a remote input being used to select the correct scaling for each or the same load cell could be used and the remote input used to toggle between different display units e.g. between Newtons and kilograms. Note: Alarm settings will not change when changing between calibrations scales. Only one set of alarm functions can be made and the alarm relay will operate from those set values no matter which calibration scale is being viewed at the time. The **dCPE**, **FAEE**, **FA9E**, **L, n Pts**, **Lo di SP**, **H, 9H di SP**, **di SP** and **ZERO FA9E** functions can be individually set for each channel. If **P.SET** is used only one preset value can be used but only the channel displayed at the time is affected. Note; using different **dCPE** settings between channels will affect the preset and alarm setpoint values e.g. a preset of **25** on a channel with **dCPE = 0** will become **2.5** on a channel with **dCPE = 0.1**. Note: the **CL.no** function can also be used to perform the same calibration select function as the **CAL.S** setting. Use only one of these methods to change selection as they will counteract each other if both are used.

P.SET - preset value. The remote input can be used to force the display to the preset value, this preset value is set at the **P.SET** function.

I.CAL - Initiate auto calibration - not available on all software versions - this function allows the user to select when an auto calibration takes place rather than relying on the instruments normal internal calibration which may cause the output to pause. Closing the external input will cause an internal calibration to take place. If the input is held closed then an internal calibration will take place periodically.

batch - the batch function does not affect the display value when operated. It does, however affect the retransmission and alarm functions, see Chapter 7 for a full description.

CAL - Calibration, when set to **CAL** the remote input can be used to perform a calibration. See Chapter 6 for details.

Print- serial “print” output - applicable only when the serial output option is fitted - allows the remote input to be used to initiate a single serial string output. The value output can be set to the live input value, the display value or one of the appropriate remote input functions. If a remote input function is selected such as **H, Lo** then in addition to the serial output function (**SEFL**) being selected as **H, Lo** a remote input (**r: NP, r: N2** or **r: N3**) or the **P** button (**Pbut**) function must also be set to **H, Lo**. The serial output will be a single string beginning with a start of text character <STX> and ending with a carriage return <CR> the value will occur between these two control characters. In the case of a **H, Lo** operation the high value will be separated from the low value by a comma. e.g.:

<STX>Hi value, Lo value<CR>.

The transmitted string is in standard ASCII format. The functions required for this “print” output command are:

Pbut, r: NP, r: N2 and **r: N3** - one of these functions must be set to **Print**. When the selected remote input is shorted to ground or the **P** button is pressed a single serial string of the value selected will be transmitted.

Print - this function must be set to **POLL**. When set to **POLL** the instruments serial communications can operate as either a “print” output or in the conventional polling mode.

SEFL - this function sets the value to be transmitted when using “print” output operation. The options are:

L, UE (live reading), the value sent will be the live input value determined from the calibration scaling and the level of the electrical input from the load cell or sensor.

tARE (tare), the value sent will follow the tared value when a remote input or **P** button has been used to tare the display.

batch (batch), the value sent will follow the batch value when a remote input or **P** button has been used for batch operation.

P.HLd (peak hold), the value sent will be the peak value whilst the peak hold operation is in progress i.e. When a remote input is being used to cause a peak hold display. The value will be reset when the **P.HLd** remote input is deactivated.

d.HLd (display hold), the value sent will be the held display value whilst the display hold operation is in progress i.e. When a remote input is being used to cause a display hold. The value will be reset when the **d.HLd** remote input is deactivated.

H (peak memory), the value sent will be the peak value in memory. This can be reset by activating the **H** remote input or **P** button for 2 seconds or by removing power to the instrument.

Lo (valley memory), the value sent will be the lowest value in memory. This can be reset by activating the **Lo** remote input or **P** button for 2 seconds or by removing power to the instrument.

d: SP (display value), the value transmitted will be whatever value is on the display at the time of a “print” operation.

H, Lo (peak, valley memory), the values sent will be the peak value in memory followed by a comma followed by the lowest value in memory. These can be reset by activating the **H, Lo** remote input or **P**

Example:

To make the serial “print” output send the peak held value using remote input 1 as the peak hold remote input and the **P** button as the “print” input:

1. Set the **r.1 NP** function to **P.HLd**
2. Set the **Pbut** function to **Q.Put**
3. Set the **Q.Put** function to **POLL**
4. Set the **SEFL** function to **P.HLd**

Whilst the remote input 1 terminal is short circuited to the GND terminal the display will show the peak held value. When the **P** button is pressed a single serial string showing the peak held value will be transmitted.

dull - display brightness control. The remote input can be used to change the display brightness. When this mode is selected the display brightness can be switched, via the remote input terminals, between the brightness level set at the **brgt** function and the brightness level set at the **dull** function.

5.31 Remote input two function

Display: **r.1 N2**
Range: Same as **r.1 NP**
Default Value: **NONE**

Remote input two function - As per **r.1 NP** function 5.30 but uses remote input 2.

5.32 Remote input three function

Display: **r.1 N3**
Range: Same as **r.1 NP**
Default Value: **NONE**

Remote input three function - As per **r.1 NP** function 5.30 but uses remote input 3.

5.33 **P** button function

Display: **Pbut**
Range: **NONE.H, .Lo.H, Lo.tARE.ZEFO.CAL.S.P.SET.btkh** or **Q.Put**
Default Value: **NONE**

P button function - a only applicable models with front panel **P** buttons. The **P** button may be set to operate some of functions also available via the remote input, see **r.1 NP** 5.30 for a description of these functions. The **P** button is located at the front of 5 or 6 digit LED models and bargraph models. If both the remote input and **P** button function are operated simultaneously the **P** button will override the remote input. The functions below are as described in the **r.1 NP** function 5.30. Functions available are: **NONE.H, .Lo.H, Lo.tARE.ZEFO.P.SET.btkh** or **Q.Put** Note: To prevent accidental operation of the **P** button in the **tARE** or **ZEFO** functions it is necessary to hold the button in for 2 seconds to perform the selected operation.

5.34 Access mode

Display: **ACCS**
Range: **OFF . EASY . NONE** or **ALL**
Default Value: **OFF**

Access mode - the access mode function **ACCS** has four possible settings namely **OFF . EASY . NONE** and **ALL**. If set to **OFF** the mode function has no effect on alarm relay operation. If set to **EASY** the “easy alarm access” mode will be activated. Refer to “Easy alarm relay adjustment access facility” page 16. If set to **NONE** there will be no access to any functions via **FUNC** mode, entry via **CAL** mode must be made to gain access to alarm and calibration functions. If set to **ALL** then access to all functions, including calibration functions, can be gained via **FUNC** mode.

5.35 Absolute display

Display: **ABS di SP**
Range: **on** or **OFF**
Default Value: **on**

The display can be set to display normally i.e. show positive and negative values (**ABS di SP** set to **OFF**) or to display only absolute values (**ABS di SP** set to **on**). When this function is set to **on** the relays fitted and the retransmission output will follow the absolute value, this applies even if the analog retransmission mode functions are set to **LI UE** or if the alarm functions **Ax** are set to **LI UE**.

5.36 Setpoint access mode

Display: **SPAC**
Range: **A 1 . A 1-2** etc.
Default Value: **A 1**

Setpoint access - seen only if more than 1 relay fitted. Sets the access via **FUNC** mode and “easy alarm access” mode to the alarm relay setpoints. The following choices are available:

A 1 - Allows setpoint access to alarm 1 only.

A 1-2 - Allows setpoint access to alarms 1 and 2 only.

A 1-3 - Allows setpoint access to alarms 1, 2 and 3 etc. up to the maximum number of relays fitted.

A remote input function (**FI NP**) must be set to **SPAC** for this function to operate. Note: Only the setpoints which have been given a value will be accessible e.g. if **A 1H** is set to **OFF** then there will be no access to the **A 1H** function when **SPAC** is used.

5.37 Lineariser points

Display: **LI n Pts**
Range: **2 . 3 . 4** or **5**
Default Value: **2**

Lineariser points - see section 6.1. Displays and sets the number of calibration scaling points to be

used.

5.38 First live calibration point

Display: **CAL 1**
Range: Any display value
Default Value: n/a

Calibration scaling first point - see section 6.1.

5.39 Second live calibration point

Display: **CAL 2**
Range: Any display value
Default Value: n/a

Calibration scaling second point - see section 6.1.

5.40 Third live calibration point

Display: **CAL 3**
Range: Any display value
Default Value: n/a

Calibration scaling third point, seen only when **LINPTS** is set to **3.4** or **5** - see section 6.1.

5.41 Fourth live calibration point

Display: **CAL 4**
Range: Any display value
Default Value: n/a

Calibration scaling fourth point, seen only when **LINPTS** is set to **4** or **5** - see section 6.1.

5.42 Fifth live calibration point

Display: **CAL 5**
Range: Any display value
Default Value: n/a

Calibration scaling fifth point, seen only when **LINPTS** is set to **5** - see section 6.1.

5.43 mV/V entry scaling method

Display: **ECAL**
Range: **- 19.999 to 32.000**
Default Value: **1.000**

mV/V scaling, seen only when **Unit Pres** is set to **2** - see section 6.2

5.44 Calibration offset

Display: **CAL OFFSE**
Range: Any display value
Default Value: n/a

Calibration offset - See section 6.3.

5.45 Set zero

Display: **SET ZERO**
Range: Any display value
Default Value: n/a

Set zero point - see section 6.5.

5.46 Zero range

Display: **ZERO RANGE**
Range: Any display value or **OFF**
Default Value: **OFF**

Zero range limit value - see section 6.6.

5.47 Zero reference point for **ZERO RANGE** operation

Display: **CAL ZERO**
Range: n/a
Default Value: n/a

Zero point calibration for **ZERO RANGE** function - see section 6.7.

5.48 Auto zero range

Display: **AUTO ZERO**

Range: **0 to 100**

Default Value: **0**

The display can be set to automatically zero its reading if the display is within the range set by the **AUTO ZERO** function for the set number of samples, see **A.2. cnt** 5.49. For example if the auto zero is set to **10** then the instrument will re-zero itself whenever the display is within **10** units of zero for the set number of samples i.e. between **-10** and **10**. Setting auto zero to **0** will disable the function and the instrument will not zero automatically. The time taken to auto zero depends upon the sample rate and the sample count **A.2. cnt** setting.

5.49 Auto zero sample count

Display: **A.2. cnt**

Range: **10 to 100**

Default Value: **10**

Displays and sets the number of samples to be taken for the auto zero function **AUTO ZERO**. For example if set to **50** then if the display is within the auto zero setting (e.g. **10**) for 50 samples then the instrument will automatically zero.

5.50 Alarm relay operation mode

Display: **A1, A2** etc.

Range: **LI, UE, TARE, btch, P.HLd, d.HLd, Hi, Lo** or **d! SP**

Default Value: **LI, UE**

Alarm relay operation mode for relays 1, 2 etc. The following choices are available for alarm operation mode:

LI, UE - live input mode. The alarm relay operation will always follow the electrical input at that time irrespective of the 7 segment display value. e.g. assume the remote input is set to **TARE** and **A1H** is set to **100**. If the instrument is tared at a display reading of **30** then the alarm will now activate at a display reading of **70**. Note that the **LI, UE** mode does not follow the electrical input if a remote input or **P** button **ZERO** operation has been undertaken. This is due to the fact that the **ZERO** operation shifts the display calibration.

TARE - tare mode. The alarm relay operation will follow the tare function. e.g. in the example above (**LI, UE**) if **A1** is set to **TARE** then the alarm would activate at a display reading of **100** (the setpoint value) rather than **70**.

btch - batch mode. The alarm relay operation will follow the batch mode operation when the **F1 NP, F1 N2, F1 N3** or **Pbut** function is set to **btch**. See section 5.30.

P.HLd - peak hold mode. When **P.HLd** is selected and the remote input is set to peak hold (**P.HLd**) then once the peak display goes above any alarm high setpoint the alarm relay will activate and will not de-activate until the peak hold is released and the display value falls below the setpoint value.

d.HLd - display hold mode. When **d.HLd** is selected and the remote input is set to display hold (**d.HLd**) then the alarm relay will be held in its present state (activated or de-activated) until the display hold is released and the display is free to change.

H - peak (max.) memory mode. When **H** is selected and the remote input is set to peak memory (**H**) then the alarm will be activated if the peak memory value is above the high setpoint value. The alarm will not de-activate until the memory is reset.

Lo - valley (min.) memory mode. When **Lo** is selected and the remote input is set to valley memory (**Lo**) then the alarm relay will be activated if the valley memory value is below the low setpoint value. The alarm will not de-activate until the memory is reset.

di SP - display mode. When **di SP** is selected the alarms will operate purely on the display value at the time i.e. if the display is showing above high setpoint or below the low setpoint value then the alarm relay will activate.

5.51 Bargraph display operation mode

Display: **BAR**

Range: **L, UE .tARE .P.HLd .d.HLd .H, .Lo** or **di SP**

Default Value: **L, UE**

The following choices are available for bargraph display mode:

L, UE - live input mode. The bargraph display will always follow the electrical input at that time irrespective of the 7 segment display value. For example if the remote input is set for peak hold operation then when the remote input is closed the 7 segment display will only show the peak value but the bargraph will be free to move up and down to follow the live input. Note that the **L, UE** mode does not follow the electrical input if a remote input or **P** button **ZERO** operation has been undertaken. This is due to the fact that the **ZERO** operation shifts the display calibration.

tARE - tare mode. The bargraph display will follow the tare function i.e fall to zero when the instrument is tared. If the remote input toggles the 7 segment display to show gross (**9705**) then the 7 segment display will change to show the gross value but the bargraph will not respond (see **L, UE** for alternative operation.)

P.HLd - peak hold mode. The bargraph (and 7 segment display) will indicate the peak value only whilst the peak value function is operated via a contact closure on the remote input i.e. the bargraph and 7 segment display can rise but not fall whilst the remote input switch is closed. When the remote input switch is opened the bargraph value will remain fixed i.e. it will not rise or fall, although the 7 segment display value will be free to alter. This peak bargraph reading can be cleared by closing the remote input switch for another operation or by temporarily removing power from the instrument. Note: In this mode the bargraph will show a zero reading until the remote input is operated for the first time after switch on.

d.HLd - display hold mode. The bargraph (and 7 segment display) value will be held whilst the remote input display hold switch is closed. When the switch is opened the bargraph value will remain fixed at the held value although the 7 segment display value will be free to alter. The held bargraph reading can be cleared by closing the remote input switch for another operation or by removing power from the instrument. Note: In this mode the bargraph will show a zero reading until the remote input is operated for the first time after switch on.

H - peak (max.) memory mode. With the peak remote input switch open the bargraph will indicate the peak value in memory i.e. the bargraph can rise but not fall. The bargraph can be

reset by clearing the memory. The memory may be cleared either by closing the remote input switch for approximately 2 seconds or by temporarily removing power to the instrument.

Lo - valley (min.) memory mode. With the valley remote input switch open the bargraph will indicate the valley (min.) value in memory i.e. the bargraph can fall but not rise. The bargraph can be reset by clearing the memory. The memory may be cleared either by closing the remote input switch for approximately 2 seconds or by temporarily removing power to the instrument.

d! SP - display mode. The bargraph display will follow whatever value is on the 7 segment display. For example if the remote input is to **tARE** then the 7 segment and bargraph will indicate the tared value and both will also be changed if the remote input toggles the displays between **nEtt** and **gFOS**. If the **bAR** function had been set to **tARE** then the bargraph would not respond to the **gFOS** toggle.

5.52 Analog/digital/serial operation mode

Display: **rEE** or **d9.OP** or **SEFL**

Range: **L, uE .tARE .btch .PHld .d.HLd .H, .Lo** or **d! SP**

Default Value: **L, uE**

This section describes the operation modes available for the retransmission options **rEE** (analog retransmission) operation mode or **rEE2** (second analog retransmission) or **d9.OP** (digital output retransmission) or **SEFL** (serial retransmission). The following choices are available:

L, uE - live input mode. The retransmission will follow the electrical input and will not necessarily follow the 7 segment or bargraph display. For example if the remote input is set for peak hold operation then when the remote input is closed the 7 segment display will only show the peak value but the retransmission will be free to change to follow the electrical input. Note that the **L, uE** mode does not follow the electrical input if a remote input or **P** button **ZEFO** operation has been undertaken. This is due to the fact that the **ZEFO** operation shifts the display calibration.

tARE - tare mode. The retransmission value will tare (fall to zero) along with 7 segment display when the remote input tare function is operated. If the remote input toggles the 7 segment display to show gross (**gFOS**) then the 7 segment display will change to show the gross value but the retransmission will not respond (see **L, uE** for alternative operation).

btch - batch mode. The output operation will follow the batch mode operation when the **r! NP**, **r! N2**, **r! N3** or **Pbut** function is set to **btch**. See section 5.30.

PHld - peak hold mode. The 7 segment display and retransmission value will indicate the peak value only whilst the peak value function is operated via a contact closure on the remote input i.e. the 7 segment display and retransmission can rise but not fall whilst the remote input switch is closed. When the remote input switch is opened the retransmission value will remain fixed i.e. it will not rise or fall, although the 7 segment display value will be free to alter. This peak retransmission output can be cleared by closing the remote input switch for another operation or by removing power from the instrument. Note: In this mode the retransmission will show a zero reading until the remote input is operated for the first time after switch on.

d.HLd - display hold mode. The 7 segment display and retransmission value will be held whilst the remote input display hold switch is closed. When the switch is opened the retransmission value will remain fixed at the held value although the 7 segment display value will be free to alter. The held retransmission output can be cleared by closing the remote input switch for another operation or by removing power from the instrument. Note: In this mode the bargraph will show a zero reading until the remote input is operated for the first time after switch on.

Hi - peak (max.) memory mode. With the peak remote input switch open the retransmission will indicate the peak value in memory i.e. the retransmission output can rise but not fall. The retransmission output can be reset by clearing the memory. The memory may be cleared either by closing the remote input switch for approximately 2 seconds or by removing power to the instrument.

Lo - valley (min.) memory mode. With the valley remote input switch open the retransmission will indicate the valley (min.) value in memory i.e. the retransmission output can fall but not rise. The retransmission output can be reset by clearing the memory. The memory may be cleared either by closing the remote input switch for approximately 2 seconds or by removing power to the instrument.

di SP - display mode. The retransmission output will follow whatever value is on the 7 segment display. For example if the remote input is set to **EARF** then the 7 segment and retransmission output will indicate the tared value and both will also be changed if the remote input toggles the displays between **REtt** and **9FOS**. If the **FEC** or **d9OP** function had been set to **EARF** then the retransmission output would not respond to the **9FOS** toggle.

5.53 Low overrange visual warning limit value

Display: **Lo di SP**
Range: Any display value or **OFF**
Default Value: **OFF**

Low overrange limit value - the display can be set to show an overrange message if the display value falls below the **Lo di SP** setting. For example if **Lo di SP** is set to **50** then once the display reading falls below **50** the message **-or-** will flash on and off or the display value will flash on and off instead of the normal display units (see **di SP** function 5.55). This message can be used to alert operators to the presence of an input which is below the low limit. If this function is not required it should be set to **OFF** by pressing the **▲** and **▼** buttons simultaneously at this function.

5.54 High overrange visual warning limit value

Display: **Hi 9H di SP**
Range: Any display value or **OFF**
Default Value: **OFF**

High overrange limit value - the display can be set to show an overrange message if the display value rises above the **Hi 9H di SP** setting. For example if **Hi 9H di SP** is set to **1000** then once the display reading rises above **1000** the message **-or-** will flash on and off or the display value will flash on and off instead of the normal display units (see **di SP** function 5.55). This message can be used to alert operators to the presence of an input which is above the high limit. If this function is not required it should be set to **OFF** by pressing the **▲** and **▼** buttons simultaneously at this function.

5.55 Display visual warning flashing mode

Display: **di SP**
Range: **FLASH** or **-or-**
Default Value: **FLASH**

Display overrange warning flashing mode - this function is used in conjunction with the **Lo di SP** and **Hi 9H di SP** functions. The **di SP** function can be set to **FLASH** or **-or-**. If the display warning value set at the **Lo di SP** or **Hi 9H di SP** function is exceeded and the **di SP** function is set to **FLASH** then the display value will flash on and off every second as a visual warning. If the display warning value set at the **Lo di SP** or **Hi 9H di SP** function is exceeded and the **di SP** function is set to **-or-** then the **-or-** message will flash on and off once a second as a visual warning. The warning flashes will cease and the normal display value will be seen when the value displayed is higher than the low limit and lower than the high limit.

5.56 Baud rate for optional serial communications

Display: **BAUD RATE**
Range: **300.600.1200.2400.4800.9600.19.2** or **38.4**
Default Value: **9600**

Set baud rate - seen only with serial output option. Refer to the separate “PM4 Panel Meter Optional Output Addendum” booklet supplied when optional outputs are fitted. Select from **300.600.1200.2400.4800.9600.19.2** or **38.4** baud. The baud rate should be set to match the device being communicated with.

5.57 Parity for optional serial communications

Display: **Prty**
Range: **NONE.EVEN** or **odd**
Default Value: **NONE**

Set parity - seen only with serial output option. Refer to the separate “PM4 Panel Meter Optional Output Addendum” booklet supplied when optional outputs are fitted. Select parity check to either **NONE**, **EVEN** or **odd**. The parity should be set to match the device being communicated with.

5.58 Output mode for optional serial communications

Display: **0.Put**
Range: **di SP.Cont.POLL, R.buS** or **ā.buS**
Default Value: **Cont**

Set serial interface mode - seen only with serial output option. Refer to the separate “PM4 Panel Meter Optional Output Addendum” booklet supplied when optional outputs are fitted. Allows user to select the serial interface operation as follows:

di SP - sends image data from the display without conversion to ASCII.

Cont - sends 8 bit ASCII form of display data at a rate typically 90% of the sample. Note if the

SEFL function is set to **d: SP** the value output will only change when the display updates i.e. approx. every 0.25 seconds.

POLL - controlled by computer or PLC as host. Host sends command via RS232/485 and instrument responds as requested.

A.buS - is a special communications mode used with Windows compatible optional PC download software. Refer to the user manual supplied with this optional software.

ā.buS - Modbus RTU protocol.

5.59 Instrument address for optional serial communications

Display: **Addr**
Range: **0 to 31**
Default Value: **0**

Set unit address for polled (**POLL**) mode (**0 to 31**) - seen only with serial output option. Refer to the separate "PM4 Panel Meter Optional Output Addendum" booklet supplied when optional outputs are fitted. Allows several units to operate on the same RS485 interface reporting on different areas etc. The host computer or PLC may poll each unit in turn supplying the appropriate address. The unit address ranges from 0 to 31 (DEC) but is offset by 32 (DEC) to avoid clashing with ASCII special function characters (such as <STX> and <CR>). Therefore 32 (DEC) or 20 (HEX) is address 0, 42 (DEC) or 2A (HEX) is address 10.

5.60 Serial mode for optional serial communications

Display: **SEFL**
Range: **L, uE .tARFE .P.HLd .d.HLd .H, .Lo .H, Lo** or **d: SP**
Default Value: **L, uE**

Seen only with serial output option - applies only when **O.PuE** function set to **Cont**. Refer to **rEC** or **rEC2** or **d9.OP** or **SEFL** function. The **H, Lo** selection in this functions allows both the peak and valley memories to be transmitted. The peak value will be transmitted followed by a space then the valley value.

5.61 Returning to normal measure mode

When the calibration has been completed it is advisable to return the instrument to the normal mode (where calibration functions are less likely to be tampered with). To return to normal mode, turn off power to the instrument, wait a few seconds and then restore power.

5.62 Error messages

SPAN Err - calibration span error. Live inputs used at **CAL 1** and **CAL 2** or other live calibration points are too close in value. The change in mV input or load applied to the cell must be at least 10% of the full range or capacity of the cell between live input calibration points. Recalibrate using inputs further apart in value. If you are certain that the inputs are far enough apart but still see the **SPAN Err** message then ignore the message and continue with the calibration. At the end of the calibration check to see if the display calibration is correct and if not recalibrate using the same inputs. If the error message persists check that

the output from the load cell has changed sufficiently by measuring the mV output at no load and with the calibration load applied. See also the **Using the I NPE display to test input level** section which follows for an easy method of checking the input level.

CAL ERR - This indicates that one of the calibration points has caused an overrange error in the analog to digital converter. Check the mV output from the load cell and check that the **RNGE** function setting is set to the correct range for the load cell used.

ZERO RNGE Err - Zero range error. Caused by an attempt to zero the display outside the allowed range. See **ZERO RNGE** function ref. 6.6.

AdC 991 n Err - This indicates that when an **ECAL** / **ESCL** method of calibration has been used the mV/V figure entered at the **ECAL** function is greater than the mV/V range entered at the **RNGE** function. The **RNGE** function should be set to be equal the **ECAL** value or to the next available value higher than the **ECAL** value.

tbLE Err or **L n tbLE Err** - these error messages indicate that the **L n PLS** function is set to a value of 3, 4 or 5 i.e. multipoint calibration for linearisation is selected and that an error in the polarity of the input has occurred. When using more than 2 calibration points it is essential that each input is greater than the previous point by at least 10% of the input range and is greater in the positive direction than the previous point. If a calibration point is seen to be more negative than the previous one the **tbLE Err** will be seen after the calibration for that point is attempted. The **L n tbLE Err** error message will be seen at power up if there has been such a calibration error and it has not been corrected. If the signal is increasing negatively then check wiring of the load cell/pressure sensor. See also the **Using the I NPE display to test input level** section which follows for an easy method of checking the input level.

Unstable display - if the display is not stable the usual cause is either that the input signal is unstable or that the calibration scaling was incorrectly attempted. Measure the load cell mV input to check for stability. If the mV input is stable recalibrate the display. See also the **Using the I NPE display to test input level** section which follows for an easy method of checking the input level.

Display shows “- - - -” - this message indicates that the input signal is higher than the range selected. Check that the **RNGE** function is set to the correct mV/V for the load cell used. If this is set correctly check that the mV input at the Signal + and Signal - terminals is within the range selected. e.g. if **RNGE** is set to **2.5** and the excitation voltage is set to 10V then the input mV signal at the Signal + and Signal - terminals should be no greater than 25mV.

Display shows -or - - this message indicates either that the number is too big to display e.g. above **9999** on a 4 digit display or that the **d: SP** function has been set to **-or -** and either the **Lo d: SP** or **Hi 9H d: SP** limits have been exceeded. You can check if this is the problem by setting the **d: SP** function to **FLSH** which will cause the display value rather than the **-or -** message to flash if the limits set have been exceeded. If the **d: SP** setting is not the problem then try recalibrating the display. If the **-or -** message is seen during calibration ignore it proceed with the calibration then check the display reading again after calibration. See also the **Using the I NPE display to test input level** section which follows for an easy method of checking the input level.

Display value flashes on and off - this indicates that the **d: SP** function ref 5.55 has been set to **FLSH** and either the **Lo d: SP** or **Hi 9H d: SP** function limits set have been exceeded.

NO ACCS - This display mean that function access has been denied. This will be due to either one of the remote input functions (**r: NP**, **r: N2** or **r: N2**) being set to **No.Ac** or that

the **ACC5** function being set to **NONE**. To override the remote input functions and gain access you can either place a short circuit between the appropriate remote input and ground or power up the instrument in **CAL** mode. To override the **ACC5** function you must power up in **CAL** mode.

NO SPAC - This display mean that function access has been denied. This will be due to either one of the remote input functions (**F.I N1**, **F.I N2** or **F.I N3**) being set to **SPAC** or the **ACC5** function has being set to **EASY** and all alarm setpoints have been set to **OFF**. To override the remote input functions and gain access you can either place a short circuit between the appropriate remote input and ground or power up the instrument in **CAL** mode. To override the **ACC5** function you must power up in **CAL** mode.

6 Calibration

Unique calibration procedures allow four different methods of calibration scaling to suit various applications. Use only one of these methods to calibrate the display.

Method 1 - (**CAL 1/SCL 1** etc.) - two, three, four or five calibration points are independently set from “live” inputs. The ability to set each point individually is useful where the calibration is being carried out on site and delays are experienced during the calibration procedure (e.g. filling tanks etc.). If two points are used the display will be linear. If more than two points are used the display can be made to follow a linearisation curve. The number of points to be used is set at the function. If more than two points are used it is essential that each point is at a higher input than the previous one.











Method 2 - (**ECAL/ESCL**) - allows entry of the mV/V figure of the load cell being used together with a scaling value i.e. no live input is required to obtain the scaling points. Note that this method is only applicable if two lineariser (**L, n Pts**) points are set.

Method 3 - (**CAL OFFst**) - allows a single point offset to be introduced.

Method 4 - (**F,1 NP** set to **CAL**) - allows a simple pushbutton calibration from a live input. This method is particularly suited to item counting applications. Note that this method is only applicable if two lineariser (**L, n Pts**) points are set.

6.1 Method 1 - calibration by entering known live input values

Method 1 uses two, three, four or five different live input values to calibrate the instrument.

1. Enter via **CAL** mode, see page 15.
2. Check that the **dcPst** and **range** functions are set as required.
3. Step through the functions until the display indicates **L, n Pts** and use the  or  pushbutton to select the number of calibration scaling points required.
4. Step through the functions until the display indicates **CAL 1**. Now press, then release, the  and  buttons simultaneously to enter the calibration functions. The display will now indicate **CAL 1** (1st calibration point) followed by a “live” reading. Apply a known input to the instrument of nominally 0% (this value is not critical and may be anywhere within the measuring range of the instrument). For example you could arrange that the load or pressure is zero at this time. When the live reading has stabilised press the  button.
5. The display will indicate **SCL 1** (scale 1) followed by the scale value in memory. Now use the  or  button to obtain the required scale value.
6. Press the  button, the display will now indicate **CAL End** (indicating that calibration of the first point is complete).
7. The display will now indicate **CAL 2** (2nd calibration point). If you do not wish to enter the second point at this stage then press and release the  button until the **FUNC End** message is seen. If you wish to enter the second point at this stage press the  and  buttons simultaneously.
8. The display will now indicate **CAL 2** (2nd calibration point) followed by a “live” reading. Apply an input greater than that used for **CAL 1** (again this value is not critical, but there needs to be a change of at least 10% of the capacity of the load cell between points).

9. When the reading has stabilised, press the **F** button, the display will now read **SCL 2** (scale 2) followed by the second scale value in memory. Use the **▲** or **▼** button to obtain the required scale value. Press the **F** button, the display will now read **CAL End** (indicating that calibration of the second point is complete).
10. Repeat the process for the remaining calibration points (**CAL 3** etc.). Note if more than 2 points are used it is essential that the higher points are more positive and are at least 10% of full scale higher than the previous points i.e. it is essential that the input is increasing in a positive direction. If an input is more negative than the previous calibration input an error message **bBLE Err** will be seen when the calibration attempt is made.

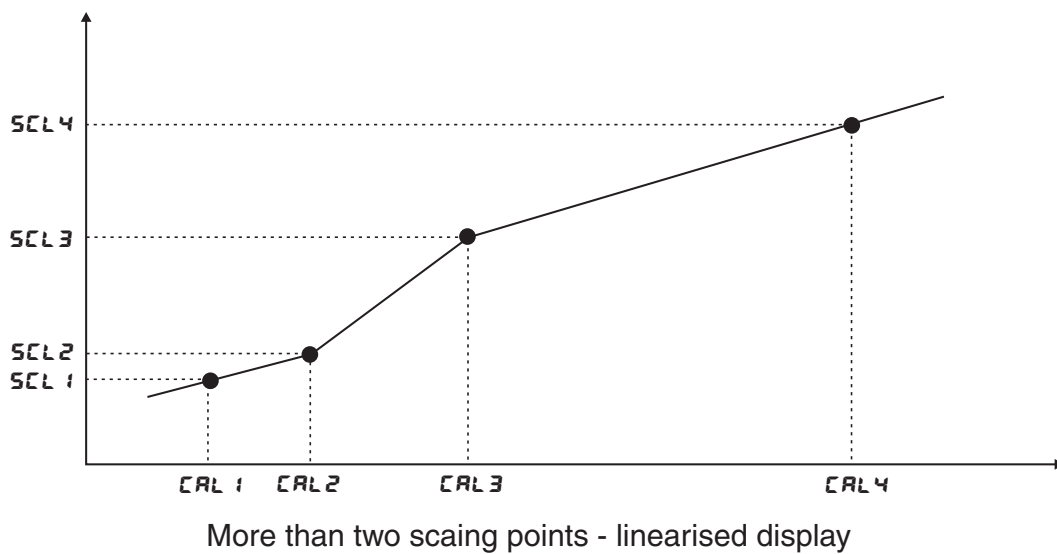
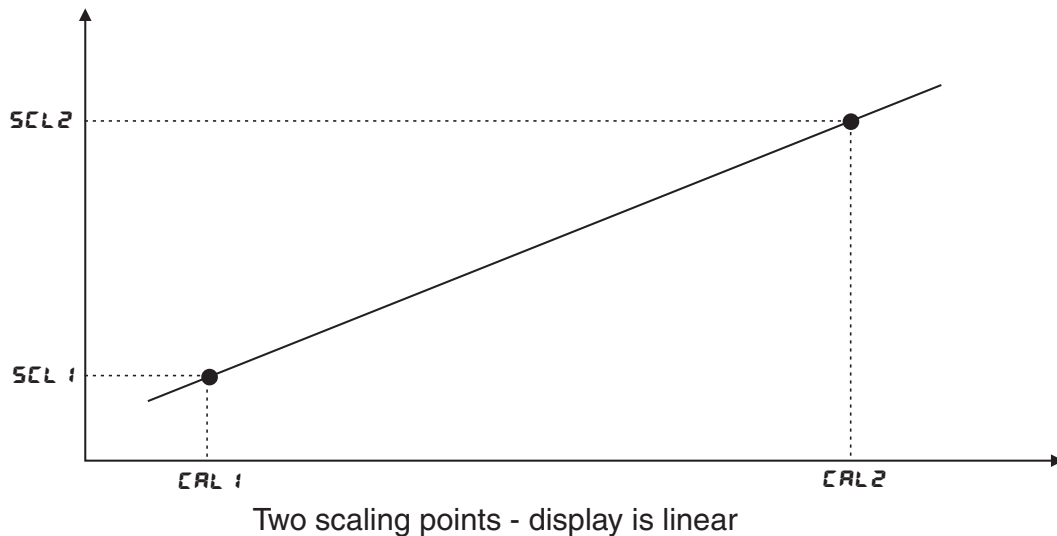

6.2 Method 2 - mV/V value entry calibration

Note: this method can only be used if the **LINE PLS** function is set to **2**. This alternative calibration method allows the known mV/V value of the load cell to be entered as the calibration value. The value is entered to 3 decimal places, any number from 32.000 to -19.999 mV/V can be input. If the required value is outside this range then use a convenient available value and alter the **ESCL** value to compensate.

1. Enter via **CAL** mode, see page 15.
2. Check that the **dCPt** and **RNGE** functions are set as required.
3. Step through the functions until the **ECAL** display is seen.
4. Press the **▲** and **▼** buttons simultaneously to get a display of the current mV/V setting. Use **▲** or **▼** to alter this value to the mV/V output of the cell being used.
5. Press and release the **F** button, the display will now show **ESCL** followed by the current scale value.
6. Use **▲** or **▼** to alter this value if required (this value is the reading required at the maximum rated load for the cell e.g. for a 100kg load cell required to display directly in kg set the **ESCL** value to **100** (or **100.0** etc. depending on the decimal point setting).
7. Press then release the **F** button the display will show **ECAL End** and the instrument moves on to the next function (**CAL OFSt**).
8. Once the **ECAL** and values have been entered you must operate the **SEt SEt ZER0** function described below or use the **P** button or remote input **ZER0** function to zero the display with the sensor connected at no load/pressure. This zeroing process will remove the effects of any no load offset outputs present at the sensor. If using the two point calibration method (method 1), as previously described, the mV/V value is automatically calculated and may be viewed at the **ECAL** function. The **ECAL** and **ESCL** values may be recorded and re-entered to re-scale the instrument to the same load cell at a later date.

6.3 Method 3 - offset calibration

CAL OFSt - Calibration offset - the calibration offset is a single point adjustment which can be used to alter the calibration scaling values across the entire measuring range without affecting the calibration slope. This method can be used instead of performing a two point calibration when a constant measurement error is found to exist across the entire range. To perform a calibration offset press the **▲** and **▼** buttons simultaneously at the **CAL OFSt** function. A “live” reading from the input will be seen, make a note of this reading. Press the **F** button, the message **SCLE** will now be seen followed by the last scale value in memory. Use the **▲** or **▼** button to adjust the scale value to the required display value for that input. For example if the “live” input reading was **50** and the required display value for this input was **70** then adjust the **SCLE** value to **70**. Press the **F** button to accept changes or the **P** button to abort the scaling. If the scaling has been accepted the message **OFSt End** should be seen. If the **ZER0 RNGE Err** message is seen refer to the **ZER0 RNGE** and **CAL ZER0** functions.

6.4 Method 4 - remote input calibration

Note: this method can only be used if the function is set to **2**. The remote input calibration method allows simple, live input, calibration suitable for situations requiring frequent calibration such as in item counting by weight applications. In this method of calibration a remote input function (e.g. **FUNCTION**) is assigned to **CAL**, closure of the remote input then initiates the calibration process. The procedure is as follows:

1. Assign a remote input (e.g. via **FUNCTION** function) to **CAL**.
2. Assign a different remote input or the **P** button to **ZERO** and zero the display when it is in a no load condition.
3. Place a weight (or known number of items) on the weighing platform then operate the **CAL** remote input i.e. close the switch.
4. The message **SCALE** will appear on the display followed by the previous scale value in memory. Use the **▲** or **▼** button to alter this reading to the value required for this load.
5. Press then release, the **F** button, the message **CAL End** will be seen and the instrument will return to normal measure mode. Note that the **P** button may be used to abort the calibration process once beyond step 3.



6.5 Set zero

Used to set the load cell system to display reading of zero. Most usually used following an **ECAL** method calibration to remove any zero offset. The set zero point is entered when the load cell is installed and in a no load condition or at the load at which the display is required to read zero. To operate the set zero function press, then release, **▲** and **▼** buttons simultaneously at the **SET ZERO** function. The zero point will be retained even if power is removed and has the same effect as the remote input or **P** button **ZERO** operation.

6.6 Zero range function

ZERO RANGE - Zero Range - the zero range function allows a limit value to be set (in engineering units) above which the display will not zero i.e. if a zero operation is attempted via the **P** button, remote input or set zero function when the display value is greater than the zero range setting the display will refuse to zero and give a **ZERO RANGE Err** message (note that the **CAL OFFSET** function is also affected by the **ZERO RANGE** setting). For example if the zero range setting is **10** the instrument will only respond to a zero operation if the display reading at the time is between **- 10** and **10**. If the zero range function is not required it can be set to **OFF** by pressing the **▲** and **▼** buttons simultaneously at this function. When switched off the instrument can be zeroed no matter what the display value. Note that the instrument keeps track of the value being zeroed at each operation, when the total amount zeroed from repeated operations becomes greater than the zero range value the instrument will reject the zero operation and a **ZERO RANGE Err** message will be seen. To allow a zero operation beyond this point either the **ZERO RANGE** function value will need to be raised or a new zero reference point introduced via the **CAL ZERO** function. If repeated zero operations are required the **ZERO RANGE** function should be set to **OFF** or alternatively the **SAFE** operation could be considered.

6.7 Zero range zero calibration function

CAL ZERO - Zero range zero calibration - a **CAL ZERO** zero operation can be used to ensure that the display zero and the **ZERO RANGE** reference zero are at the same point after a calibration. After a calibration the **CAL ZERO** operation can also be used to select a zero point other than the display zero as the reference for the **ZERO RANGE** function. For example if the **CAL ZERO** operation is carried out with a display reading of **500** and a **ZERO RANGE** reading of **10** the zero range function will allow the display to zero only if the current display reading is between **490** and **510**. To perform a calibration zero press the  and  buttons simultaneously at the **CAL ZERO** function, a live reading will be seen, press the  button, the message **CAL ZERO End** should now be seen indicating that the instrument has accepted the zero point. Although the display reading will not change as a result of the calibration zero the input value on the display at the time of the operation will be the new zero reference point for the **ZERO RANGE** function.

7 Batching operation

The remote inputs **F.I.NP**, **F.I.N2** and **F.I.N3** and the **P** button function (**Pbut**) may be programmed to operate in batch (**btch**) mode. Operation of any of these inputs in batch mode will have no effect on the displayed value (i.e. the total load or weight is always visible) but can be made to affect the method in which the setpoint alarm relays and retransmission options operate.

Alarm operation in batch mode

In addition to setting the required remote input or **P** button function to **btch** the alarm mode function for the required alarm operation mode must also be set to **btch**. The alarm operation mode functions are **A1** for alarm 1, **A2** for alarm 2 (if fitted), **A3** for alarm 3 (if fitted) etc.

When in batch mode the selected alarm may be set to operate at a given batch figure i.e. **AILO** or **AIH**, can be allocated batch values.

Example: Assume that the display is scaled to read in kilograms up to a maximum of 1000kg. **F.I.NP** is set to **btch** and **A1** is also set to **btch**. **AIH**, is set to **100**, **AILO** is set to **OFF** and **AHY** is set to **0**. If the display reading is **300** when the remote input is operated then the display will not alter but alarm 1 relay will now activate when the display reading increases by the batch value of **100** i.e. at a value of **400** or above.

The effect on alarm settings for the same example is shown in the table below.

Relay settings with AHY = 0	Relay deactivates	Relay activates
AILO = OFF, AIH = 100	At values below 400	At values above 400 i.e. 300 + the batch value
AILO = OFF, AIH = -100	At values below 200	At values above 200
AILO = 100, AIH = OFF	At values above 400	At values below 400
AILO = -100, AIH = OFF	At values above 200	At values below 200
AILO = 50, AIH = 100	At values between 350 and 400	At values below 300 or above 400

The effect of a hysteresis setting (setting **AHY** to **10** in this example) is shown in the table below.

Relay settings with AHY = 10	Relay deactivates	Relay activates
AILO = OFF, AIH = 100	At values below 390	At values above 400 i.e. 300 + the batch value
AILO = OFF, AIH = -100	At values below 190	At values above 200
AILO = 100, AIH = OFF	At values above 410	At values below 400
AILO = -100, AIH = OFF	At values above 210	At values below 200

Example: Assume that **AIH**, is set to **-25.0** and that the instrument is given a remote batch input when the display reads **200.0** i.e. the alarm relay is activated at this stage. The display does not alter when a batch input is applied but alarm 1 will not reset until the display goes below **175.0** (**200** minus **25.0**). i.e. once the batch input is applied the display value must decrease by the alarm value before the alarm will reset.

7.1 Retransmission operation in batch mode

As with the alarm operation the display value does not alter once the batch function has been operated. The retransmission value will, however, will be affected. Functions to set the retrans-

mission to follow the batch operation are **FEC** or **FEC2** for analog retransmission , **RSOP** for digital retransmission. For serial retransmission the display must receive a request to operate its remote input function (using the “Reset special function value” command , refer to the separate booklet “PM4 Panel Meter Optional Output Addendum”).

Example

The analog retransmission has been set via the **FEC** and **FEC2** functions to transmit a 4mA signal at a display value of **0** and to transmit a 20mA signal at a display value of **1000**. The **FEC** or **FEC2** and **RSOP** functions have been set to **batch**. If the remote input is operated when the display value is **80** then the display will now transmit 4mA at a display value of **80** and will transmit 20mA at a display value of **1080**. The analog retransmission could be input to a PLC or other device for control purposes.

8 Specifications

8.1 Technical specifications

Input:	Ratiometric 4 or 6 wire strain gauge. (6 wire not available on LCD and 4 digit display models)
Input Sensitivity:	80 Ω to more than 2000 Ω (use 5V excitation if less than 350 Ω)
Excitation:	10V or 5V, link selectable
Accuracy:	Up to 0.005% of full scale for alarms and display, depending on sample rate etc., see resolution table which follows. Accuracy for analog retransmission better than 0.05% system accuracy Using ECAL and ESCL calibration method accuracy is 1%
Sample rate:	10 to 100 sample per second, selectable. Note that output options such as serial or analog output will be updated at a slightly lower rate e.g. at 100 samples/sec. the output option will typically update at approximately 90 per second
ADC Resolution:	Up to 22 bits depending on sample rate and mV/V input, see 8.4
Display update:	Up to 4 per second, varies with FLEP setting
Conversion Method:	Sigma delta
Microprocessor:	HC68HC11F CMOS
Ambient temperature:	LED -10 to 60° C, LCD -10 to 50° C
Humidity:	5 to 95% non condensing
Display:	LED Models: 4 digit 20mm, 5 digit 14.2mm + status LEDs + 4 way keypad. 6 digit 14.2mm + 4 way keypad LED Bar Graph 20 segment bar + 5 digit 7.6mm + relay status LEDs LCD Models: 4 digit 12.7mm, 6 digit 12.7mm
Power supply:	AC 240V, 110V or 24V 50/60Hz or DC isolated wide range 12 to 48V. Special supply types 32VAC, 48VAC 50/60Hz or DC isolated 50 to 110V also available. Note: supply type is factory configured.
Power consumption:	AC supply 4 VA max, DC supply typically 150mA at 12VDC and 75mA at 24VDC for PM4 with 350 Ω load, no optional outputs, actual current drawn depends on display type and options fitted
Output (standard):	1 x relay, Form A, rated 5A resistive. Programmable N.O. or N.C

8.2 Optional outputs

Extra relays:	One or six extra relay option - same specs. as Relay 1 Three extra relay option - same specs as Relay 1 but form C (changeover).
Analog retransmission:	12 bit isolated 4 to 20mA, 0 to 1V or 0 to 10V link selectable (single or dual analog output versions available). (4-20mA will drive into resistive loads of up to 800 Ω)
Digital retransmission:	Isolated BCD/Binary
Serial communications:	Isolated RS232 or RS485 (ASCII or Modbus RTU)
DC supply output:	Isolated \pm 12V(24V) standard, \pm 5V(10V) link selectable (rated at 25mA).

8.3 Physical characteristics

Bezel size:	DIN 48mm x 96mm x 10mm
Case size:	44mm x 91mm x 120mm behind face of panel
Panel cut out:	45mm x 92mm +1mm/-0mm
Connections:	Plug in screw terminals (max. 2.5mm ² wire)
Weight:	400 gms basic model, 450 gms with option card

8.4 Resolution table

Effective resolution (bits) for PM4-WT over full scale							
Samples/sec.	mV/V input						
	0.5mV/V	1mV/V	2.5mV/V	5mV/V	10mV/V	25mV/V	50mV/V or 100mV/V
5	15.5	16.5	17.5	18.5	19.5	20.5	20.5
10	15.5	16.5	17.5	18.5	19.0	19.0	19.0
15	15.5	16.5	17.5	18.5	18.5	19.0	19.0
20	15.5	16.5	17.5	18.0	18.5	18.5	18.5
30	15.5	16.5	17.5	18.0	18.5	18.5	18.5
50	15.0	16.0	16.5	17.0	17.5	17.5	17.5
100	14.0	14.0	14.5	14.5	15.0	15.0	14.5

Note: Figures in the table above apply when the digital filter setting is 0. Add 0.5 bits effective resolution for each step on the digital filter setting e.g. if the digital filter is set at 4 add 2 bits of effective resolution to each of the figures in the table above.

Resolution in μV can be calculated using the resolution in bits figures above. These μV resolution values are calculated by the following method:

Resolution (μV) = full signal input voltage range / number of divisions of resolution.

e.g. for 2.5mV/V range, 10V excitation, full signal input voltage is 2.5mV x 10V excitation = 25mV.

For 14.5 bits (100 samples/sec., zero filter) the number of divisions is $2^{14.5}$ which equals 23170 divisions.

For 21.5 bits (5 to 30 samples/sec, filter setting of 8) the number of divisions is 2965820 ($2^{21.5}$).

Resolution (μV) at 14.5 bits = (2.5 mV x 10) / 23170 = 1.08 μV

Resolution (μV) at 21.5 bits = (2.5 mV x 10) / 2965820 = 0.0084 μV

9 Guarantee and service

The product supplied with this manual is guaranteed against faulty workmanship for a period of two years from the date of dispatch.

Our obligation assumed under this guarantee is limited to the replacement of parts which, by our examination, are proved to be defective and have not been misused, carelessly handled, defaced or damaged due to incorrect installation. This guarantee is VOID where the unit has been opened, tampered with or if repairs have been made or attempted by anyone except an authorised representative of the manufacturing company.

Products for attention under guarantee (unless otherwise agreed) must be returned to the manufacturer freight paid and, if accepted for free repair, will be returned to the customers address in Australia free of charge.

When returning the product for service or repair a full description of the fault and the mode of operation used when the product failed must be given. In any event the manufacturer has no other obligation or liability beyond replacement or repair of this product.

Modifications may be made to any existing or future models of the unit as it may deem necessary without incurring any obligation to incorporate such modifications in units previously sold or to which this guarantee may relate.

This document is the property of the instrument manufacturer and may not be reproduced in whole or part without the written consent of the manufacturer.

This product is designed and manufactured in Australia.