

PM4-RT8
Multi Input RTD
Process Monitor/Controller
Operation and Instruction Manual

AMALGAMATED INSTRUMENT CO

Unit 5/28 Leighton Place Telephone: (02) 9476 2244 www.aicpl.com.au
Hornsby NSW 2077 Australia Facsimile: (02) 9476 2902 E-mail: sales@aicpl.com.au

ABN 80 619 963 692

Quality
Endorsed
Company

Quality System





AS/NZS
ISO 9001
Lic. No.
QEC 6187
Standards
Australia

Table of Contents

Introduction	3
Basic setup	3
Calibration	3
PM4-RT8 inputs & outputs	3
Mechanical Installation	4
Input/Output Configuration	5
Electrical Installation	6
RTD connection examples	7
Power supply connections	7
Relay connections	7
Remote input connections	7
Explanation of Functions	8
Easy alarm relay adjustment access facility	9
Error messages	23
Function Table	24
Specifications.	26
Technical Specifications	26
Output Options	26
Physical Characteristics.	26
Guarantee and Service	27

1 Introduction

This manual contains information for the installation and operation of the PM4-RT8 Monitor. The PM4 can accept up to four 4 wire RTDs or eight 2 wire RTDs. One input type can be selected for all inputs the choice of input type is Pt100 or Pt1000 RTD. Resolution can be selected as 1° or 0.1°. The display can be set to automatically scroll through each input or the  or  button can be used to manually scroll through each input display.

The instrument may be calibrated to display in °C, °F or °K. A standard inbuilt relay provides an alarm/control function. Optional extra relays analog or binary/BCD retransmission or serial communications may also be provided. Relays can be set for latching or non latching operation.

Unless otherwise specified at the time of order, your PM4 has been factory set to a standard configuration. Like all other PM4 series instruments the configuration and calibration is easily changed by the user. Full electrical isolation between power supply, input and retransmission output (optional) is provided by the PM4, thereby eliminating grounding and common voltage problems. This isolation feature makes the PM4 ideal for interfacing to computers, PLCs and other data acquisition devices.

The versatile PM4 has various front panel layout options, in some cases the pushbuttons may be located on the front panel as well as the standard rear panel configuration. The PM4-RT8 is available in 5, 6 or 5 digit plus bargraph LED display form.

The PM4 series of Panel Mount Monitors are designed for high reliability in industrial applications. The high brightness LED display provides good visibility, even in areas with high ambient light levels.

1.1 Basic setup

The steps below allow a basic setup for temperature display. Refer to the "Explanation of Functions" chapter for a description of the functions mentioned below and for a description of other functions which may be required. The basic setup requirements to obtain temperature displays for each input are:

1. Connect the inputs as shown in "Electrical Installation" chapter
2. Enter **CAL** mode as shown at the beginning of the "Explanation of Functions" chapter
3. Step through to the **INPUT TYPE** function and select the input type
4. Step through to the **RTD TYPE** function and select the RTD type required
5. Step through to the **INPUT CHAN** function and select the number of inputs required
6. Step through to the **SET DISPLAY** function and select the display type required
7. Step through to the **DES TYPE** function and select the units for display then press **F** to accept this last change.
8. Press **P** to exit the function setup display and return to the measurement display.

1.2 Calibration

A single point calibration is available for each channel. If the sensor type is changed each channel will have to be recalibrated. The calibration functions for each channel are named **CH1CAL** for channel 1 calibration, **CH2CAL** for channel 2 calibration. See "Explanation of Functions" chapter for details.

1.3 PM4-RT8 inputs & outputs

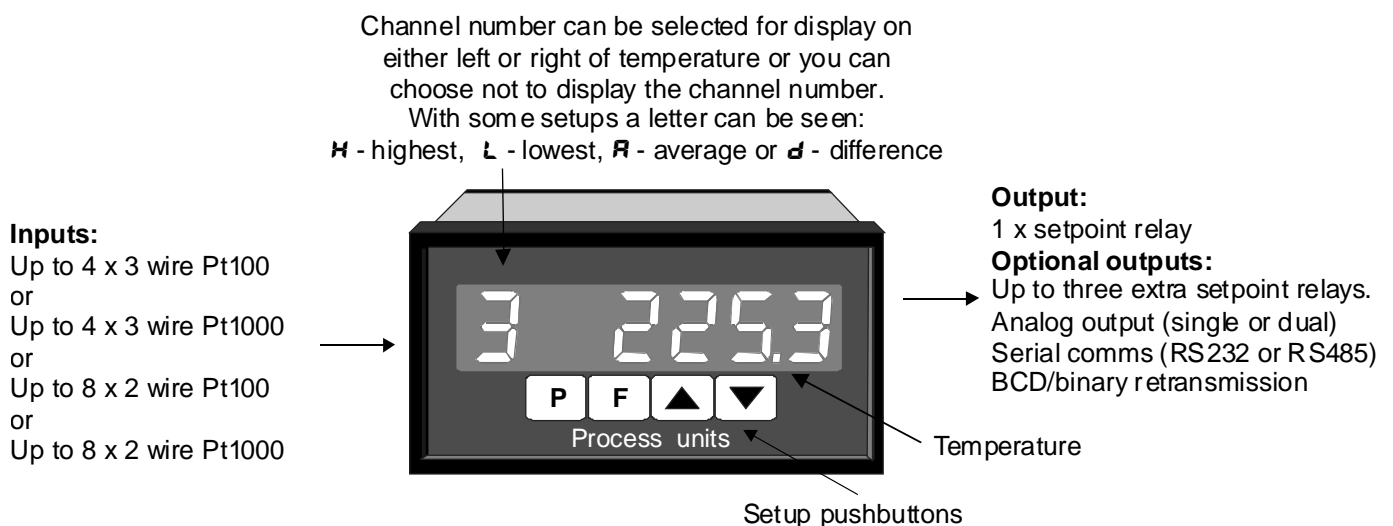

2 Mechanical Installation

If a choice of mounting sites is available then choose a site as far away as possible from sources of electrical noise such as motors, generators, fluorescent lights, high voltage cables/bus bars etc. An IP65 access cover which may be installed on the panel and surrounds is available as an option to be used when mounting the instrument in damp/dusty positions. A wall mount case is available, as an option, for situations in which panel mounting is either not available or not appropriate. A portable carry case is also available, as an option, for panel mount instruments.

Prepare a panel cut out of 45mm x 92mm +1 mm / -0 mm (see diagram below). Insert the instrument into the cut out from the front of the panel. Then, from the rear of the instrument, fit the two mounting brackets into the recess provided (see diagram below). Whilst holding the bracket in place, tighten the securing screws being careful not to over-tighten, as this may damage the instrument.

Hint: use the elastic band provided to hold the mounting bracket in place whilst tightening securing screws.

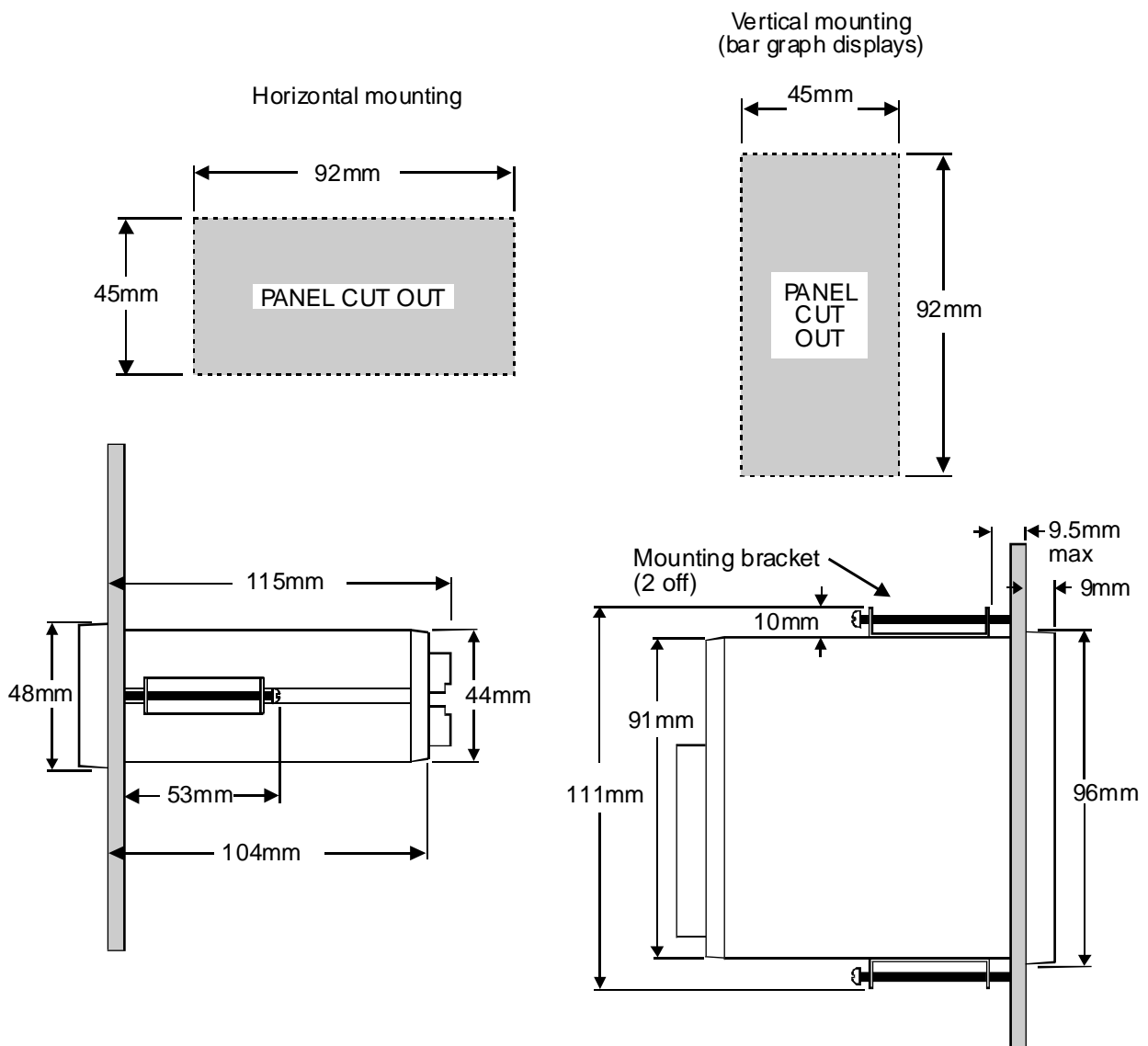

3 Input/Output Configuration

If you need to alter the input or output configuration proceed as follows:

1. Remove the plug in terminals from the rear of the instrument

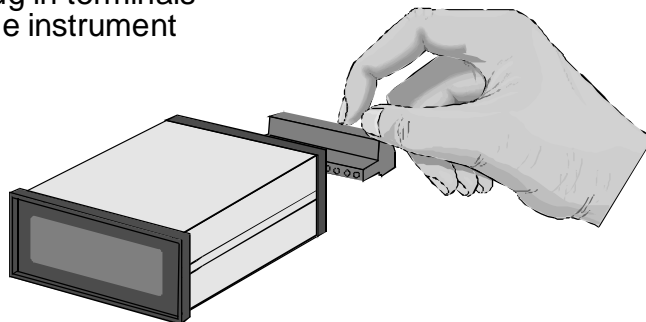

2. Remove 4 x self tapping screws from back cover, remove back cover by pulling it away from the instrument

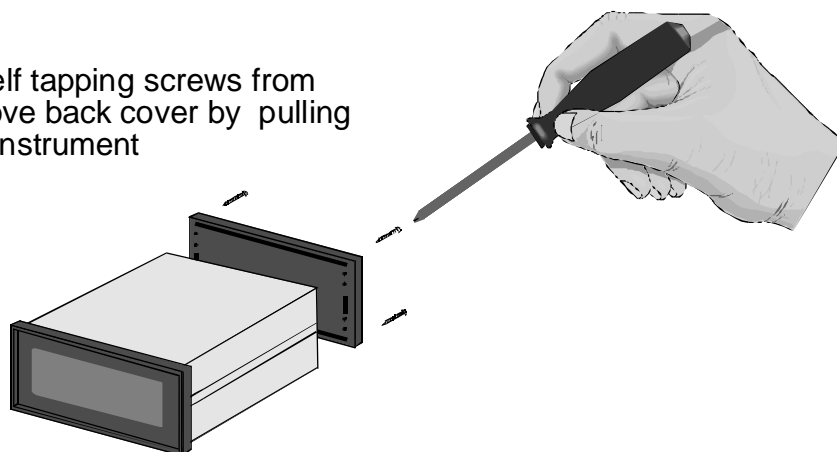

3. Using a screwdriver, remove the earth screw which passes through the case then slide out the board or boards

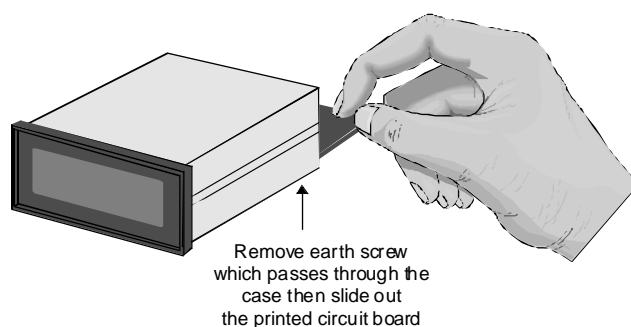

4. Configure the PCB links as required, see appropriate chapter
5. Slide PCB back into the case
6. Replace the earth screw which passes through the case
7. Refit back cover and fix with the self tapping screws
8. Plug the terminal strips back into the rear of the instrument

4 Electrical Installation

The PM4 Panel Meter is designed for continuous operation and no power switch is fitted to the unit. It is recommended that an external switch and fuse be provided to allow the unit to be removed for servicing.

The plug in, screw type, terminal blocks allow for wires of up to 2.5mm² to be fitted. Connect the wires to the appropriate terminals as indicated below. Refer to connection details provided in this chapter to confirm proper selection of voltage, polarity and input type before applying power to the instrument. When power is applied to the instrument will cycle through a display sequence indicating the software version and other status information, this indicates that the instrument is functioning. Acknowledgement of correct operation may be obtained by applying an appropriate input to the instrument and observing the reading. The use of screened cable is recommended for signal inputs.

For wiring details for optional outputs refer to the separate "PM4 Panel Meter Optional Output Addendum" booklet supplied when options are fitted.

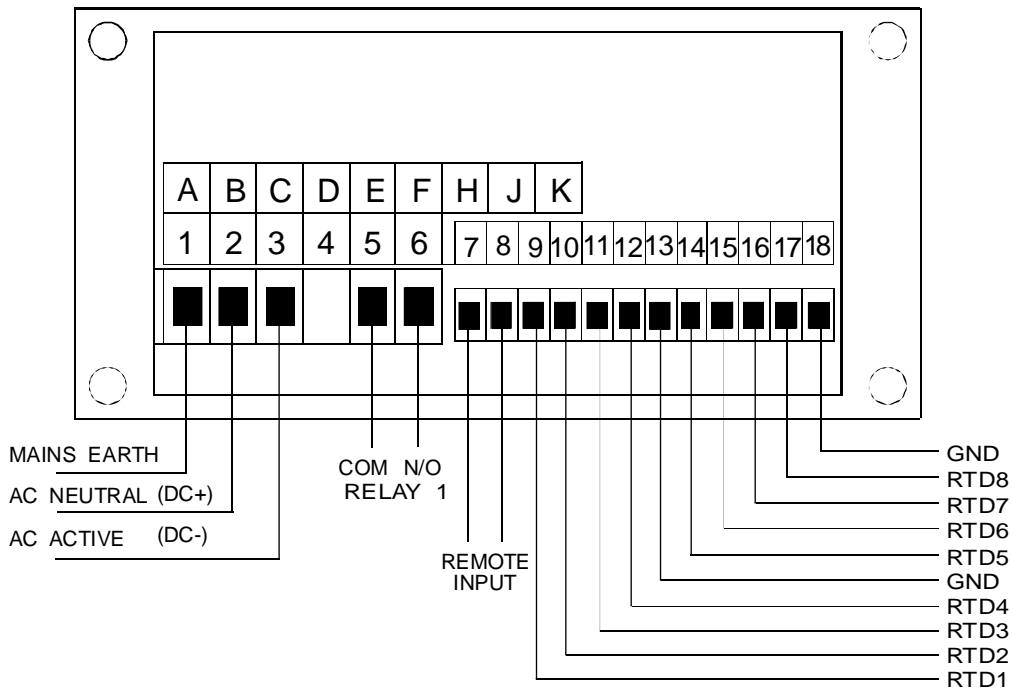

Instrument rear panel - 2 wire connection

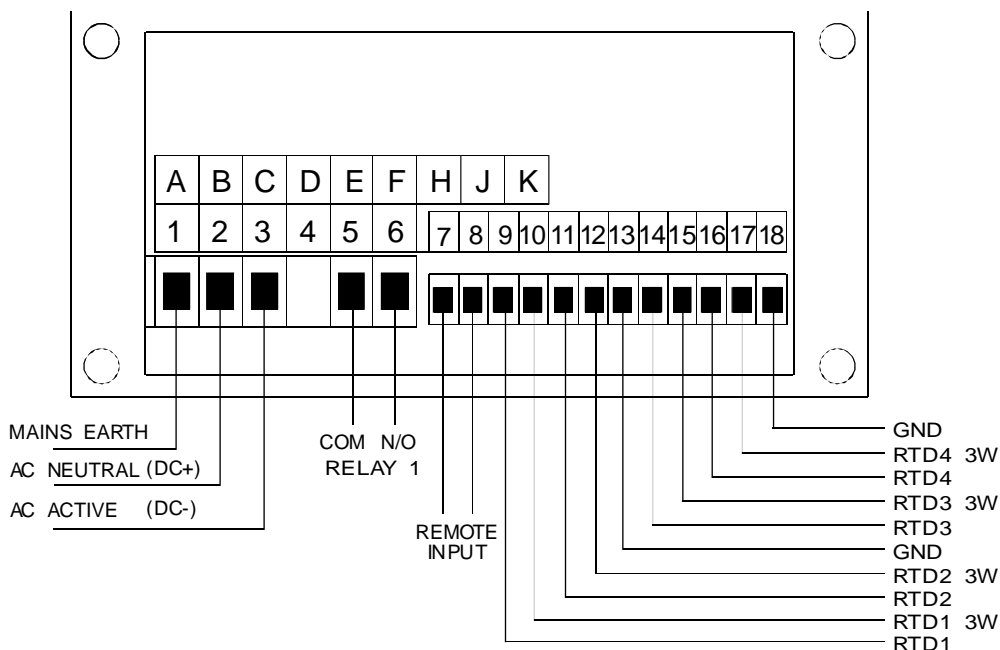

Instrument rear panel - 3 wire connection

4.1 RTD connection examples

Example - 4 x 2 wire RTD

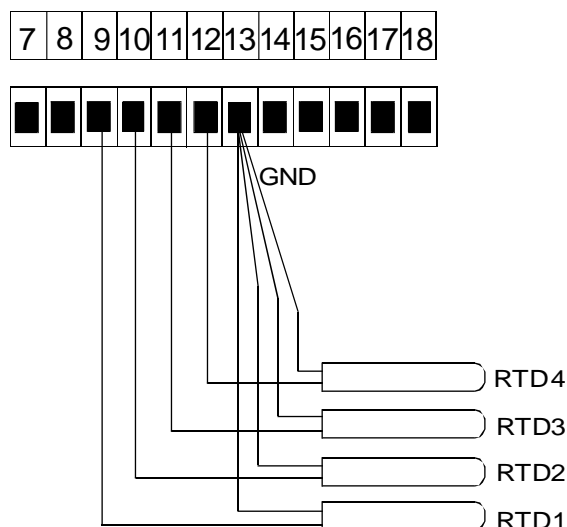

Example - 3 x 3 wire RTD

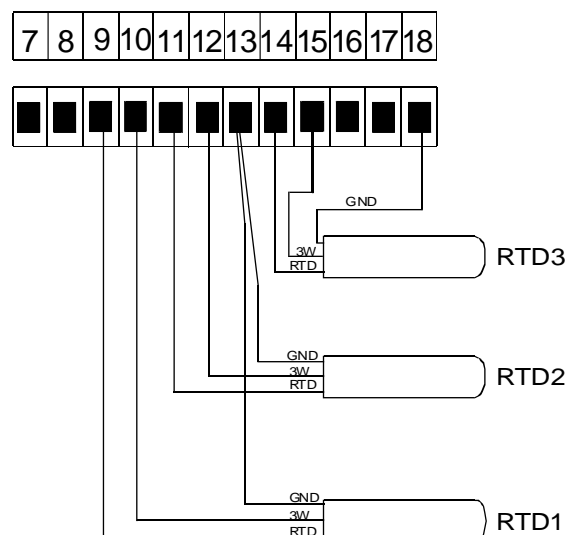

4.2 Power supply connections

The power supply for the instrument is factory fitted and is of a fixed type. If you are unsure of the supply requirement for your instrument it can be determined by the model number on the instrument label:-

- PM4-RT8-240-..... Requires 240VAC
- PM4-RT8-110-..... Requires 110VAC
- PM4-RT8-24-..... Requires 24VAC
- PM4-RT8-DC-..... Requires between 12 and 48VDC
- PM4-RT8-DCH-..... Requires between 50 and 110VDC

4.3 Relay connections

The PM4 is supplied with one alarm relay as standard with connections on terminals 5 and 6. Extra relays are optionally available. The relay is a single pole, single throw type (form A) and is rated at 5A, 240VAC into a resistive load. The relay contact is voltage free and may be programmed for normally open or normally closed operation.

4.4 Remote input connections

Terminals 7 & 8 are the remote input terminals. The operation selected by the **F.1** **NP** function is activated when terminals 7 & 8 are shorted via switch, relay etc.

5 Explanation of Functions

The PM4 setup and calibration functions are configured through a push button sequence. Two levels of access are provided for setting up and calibrating:-

FUNC mode (simple push button sequence) allows access to commonly set up functions such as alarm setpoints. **CAL** mode (power up sequence plus push button sequence) allows access to all functions including calibration parameters.

The three push buttons located at the rear of the instrument (also at the front on some display options) are used to alter settings. Once **CAL** or **FUNC** mode has been entered you can step through the functions, by pressing and releasing the **F** push button, until the required function is reached. Changes to functions are made by pressing the **▲** or **▼** push button (in some cases both simultaneously) when the required function is reached. See the flow chart example on the following page.

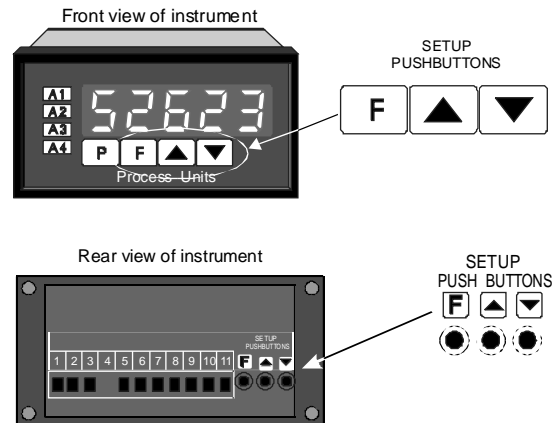

Note: the **ACCESS** or **F.1: NP** function can be used to block access to **FUNC** mode.

Entering **CAL** Mode



1. Remove power from the instrument. Hold in the **F** button and reapply power. The display will briefly indicate **CAL** as part of the "wake up messages" when the **CAL** message is seen you can release the button. Move to step 2 below.



2. When the "wake up" messages have finished and the display has settled down to its normal reading press, then release the **F** button. Move to step 3 below.

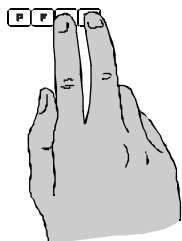

3. Within 2 seconds of releasing the **F** button press, then release the **▲** and **▼** buttons together. The display will now indicate **FUNC** followed by the first function.

Note: If step 1 above has been completed then the instrument will remain in this **CAL** mode state until power is removed. i.e. there is no need to repeat step 1 when accessing function unless power has been removed.

Entering **FUNC** Mode

No special power up procedure is required to enter **FUNC** mode.



1. When the "wake up" messages have finished and the display has settled down to its normal reading press, then release the **F** button.



2. Within 2 seconds of releasing the **F** button press, then release the **▲** and **▼** buttons together. The display will now indicate **FUNC** followed by the first function.

Alternative **CAL** Mode Entry

This alternative method allows **CAL** mode entry without the need to remove power:

1. Enter **FUNC** mode using the 2 steps above
2. When the first function appears press and hold the **P** button until you see the message **FUNC** followed by **CAL** (the **P** button will have to be held pressed for approximately 2 seconds)
3. You should now return to the function you were in but have full access to **CAL** mode functions

Note: when you exit back to live reading the PM4 will remain in **CAL** mode for approximately 4 minutes, after this time you will need to repeat this process to enter **CAL** mode.

Example: Entering **FUNC** mode to change alarm 1 high function **A 1H**, from **OFF** to **100**

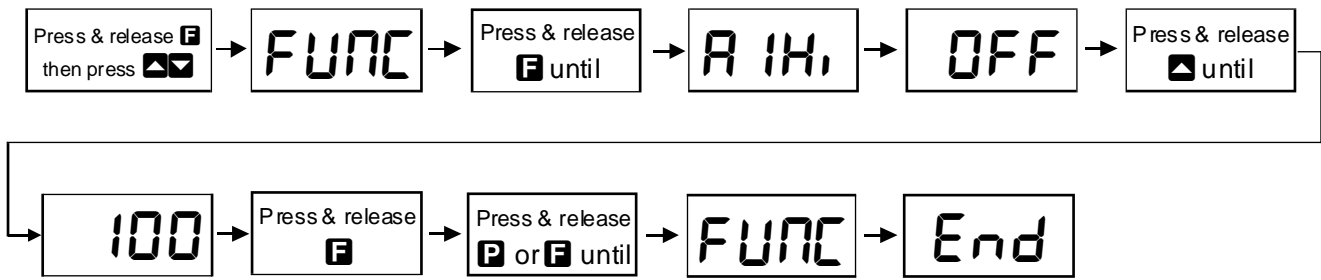

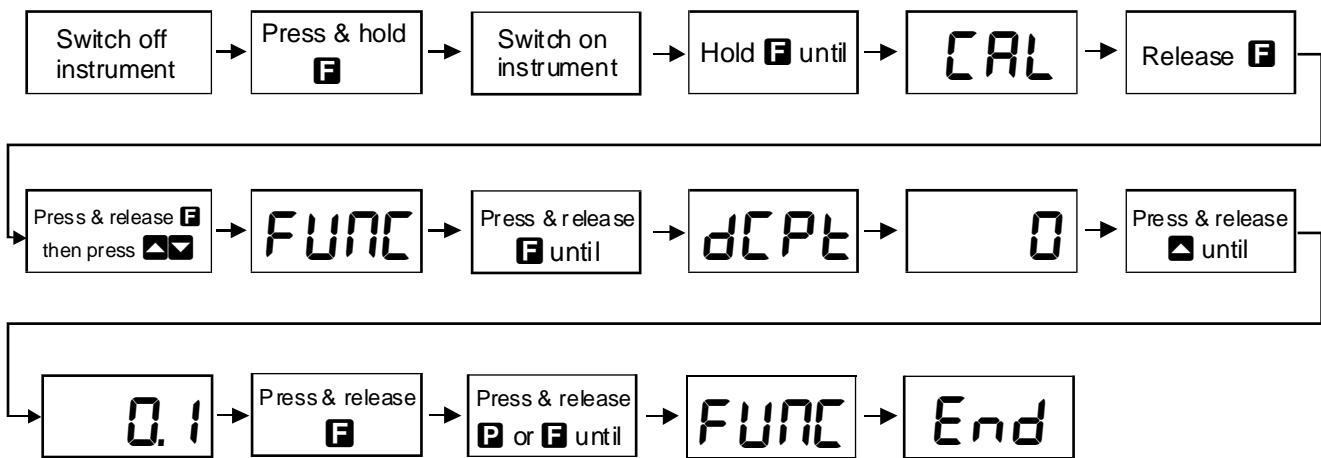

Example: Entering **CAL** mode to change decimal point **dCPLt** function from **0** to **0.1**



The alarm and brightness functions below are accessible via **FUNC** mode.









Note that “x” in the alarm functions is used to indicate any alarm number e.g. if 3 setpoint alarm relays are fitted then **A 1Lo**, **A2Lo** and **A3Lo** will all be seen as functions on the display.

5.1 Easy alarm relay adjustment access facility

The PM4-RT8 has an easy alarm access facility which allows access to the alarm setpoints simply by pressing the **F** button at the front or rear of the instrument. The first setpoint will then appear and changes to this setpoint may be made to this setpoint via the  or  buttons. Press the **F** button to accept any changes or to move on to the next setpoint. Note: this easy access also functions in the same manner for the PI control setpoint (relay and/or analog PI output). For further details of analog PI easy setpoint access refer to the separate “PM4 Panel Meter Optional Output Addendum” booklet supplied when this option is fitted.

The instrument must be set in the manner described below to allow the easy access facility to work:

1. The **F.1 NP** function must be set to **SP.AC** or the **ALCS** function must be set to **EASY**.
2. At least one alarm must have a setpoint, nothing will happen if all the alarm setpoints are set to **OFF**.
3. The **SP.AC** function must be set to allow access to the relays required e.g. if set to **A 1-2** then the easy access will work only with alarm relays 1 and 2 even if more relays are fitted.
4. The instrument must be in normal measure mode i.e. if the instrument is powered up so that it is in **CAL** mode then the easy access will not function. If in doubt then remove power from the instrument, wait for a few seconds then apply power again.
5. If the easy access facility is used then the only way to view or alter any other function settings is to power up via **CAL** mode i.e. there is no entry to **FUNC** mode unless the instrument is powered up in **CAL** mode.





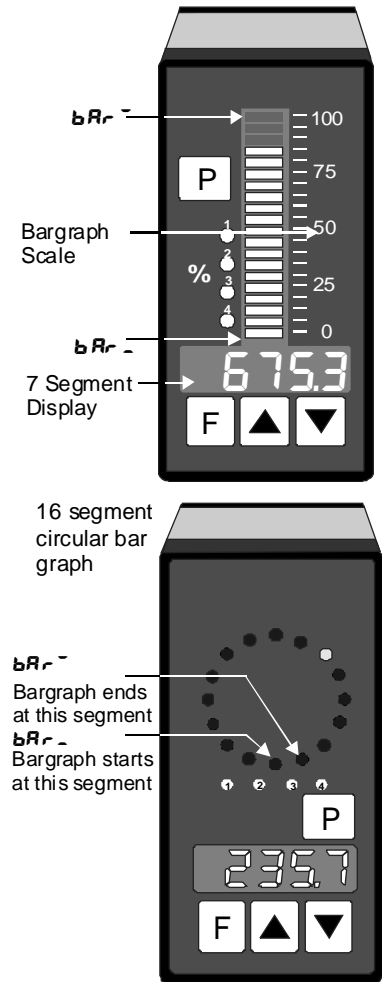

Function	Range	Description
RxLo	Value	Alarm low setpoint - displays and sets the low setpoint value for the designated alarm relay. The low alarm setpoint may be disabled by pressing the  and  pushbuttons simultaneously. When the alarm is disabled the display will indicate OFF . Use  or  to adjust the setpoint value if required. The alarm will activate when the displayed value is lower than the setpoint value. Each relay may be configured with both a low and high setpoint if required, if so the relay will be activated when the display reading moves outside the band set between low and high setpoints.
RxHi	Value	Alarm high setpoint - displays and sets the high setpoint value for the designated alarm relay. The high alarm setpoint may be disabled by pressing the  and  pushbuttons simultaneously. When the alarm is disabled the display will indicate OFF . Use  or  to adjust the setpoint value if required. The alarm will activate when the displayed value is higher than the setpoint value. Each relay may be configured with both a low and high setpoint if required, if so the relay will be activated when the display reading moves outside the band set between low and high setpoints.
RxHy	0 to 9999 units	Alarm hysteresis [deadband] - displays and sets the alarm hysteresis limit and is common for both high and low setpoint values. The hysteresis value may be used to prevent too frequent operation of the setpoint relay when the measured value stays close to the setpoint. Without a hysteresis setting (RxHy set to zero) the alarm will activate when the display value goes above the alarm setpoint (for high alarm) and will reset when the display value falls below the setpoint, this can result in repeated on/off switching of the relay at around the setpoint value. The hysteresis setting operates as follows: In the high alarm mode, once the alarm is activated the input must fall below the setpoint value minus the hysteresis value to reset the alarm. e.g. if RxHi is to 50.0 and RxHy is set to 3.0 then the setpoint output relay will activate once the display value goes above 50.0 and will reset when the display value goes below 47.0 (50.0 minus 3.0). In the low alarm mode, once the alarm is activated the input must rise above the setpoint value plus the hysteresis value to reset the alarm. e.g. if RxLo is to 20.0 and RxHy is set to 10.0 then the alarm output relay will activate when the display value falls below 20.0 and will reset when the display value goes above 30.0 (20.0 plus 10.0). The hysteresis units are expressed in displayed engineering units.
RxTt	0 to 999.9 seconds	Alarm trip time - displays and sets the alarm trip time and is common for both alarm high and low setpoint values. The trip time is the delay time before the alarm relay will activate, or trip, when an alarm condition is present. The alarm condition must be present continuously for the trip time period before the alarm will trip. This function is useful for preventing an alarm trip due to short non critical deviations from setpoint. The trip time is selectable over 0 to 999.9 seconds.
Rxrt	0 to 999.9 seconds	Alarm reset time - displays and sets the alarm relay reset time. With the alarm condition is removed the alarm relay will stay in its alarm condition for the time selected as the reset time. The reset time is selectable over 0 to 999.9 seconds.
Rxn.o or Rxn.c	Rxn.o or Rxn.c	Alarm x normally open or normally closed - displays and sets the setpoint alarm relay action to normally open (de-energised) or normally closed (energised), when no alarm condition is present. A normally closed alarm is often used to provide a power failure alarm indication.













Function	Range	Description																				
Rx SP, Rx.t 1, Rx.t 2 etc.	Rx SP, Rx.t 1, Rx.t 2 etc.	<p>Relay operation independent setpoint or trailing setpoint - each alarm may be programmed to operate with an independent setpoint setting or may be linked (or trailing) to operate at a fixed difference to another relay setpoint. The operation is as follows:</p> <p>Alarm 1 (R1) is always independent. Alarm 2 (R2) may be independent or may be linked to Alarm 1. Alarm 3 (R3) may be independent or may be linked to Alarm 1 or Alarm 2. Alarm 4 (R4) may be independent or may be linked to Alarm 1, Alarm 2 or Alarm 3. The operation of each alarm is selectable within the Function Setup Mode by selecting, for example, (Alarm 4) R4.SP = Alarm 4 normal setpoint or R4.t 1 = Alarm 4 trailing Alarm 1 or R4.t 2 = Alarm 4 trailing Alarm 2 or R4.t 3 = Alarm 4 trailing Alarm 3. For trailing set points the setpoint value is entered as the difference from the setpoint being trailed. If the trailing setpoint is to operate ahead of the prime setpoint then the value is entered as a positive number and if operating behind the prime setpoint then the value is entered as a negative number. For example, with Alarm 2 set to trail alarm 1, if R1.H. is set to 100 and R2.H. is set to 50 then Alarm 2 will activate at 100 and alarm 2 will activate at 150 (i.e. 100 + 50). If Alarm 2 had been set at -50 then alarm 2 would activate at 50 (i.e. 100 - 50). See the trailing alarm table which follows.</p> <table border="1" data-bbox="438 795 1444 1041"> <thead> <tr> <th colspan="4">Trailing Alarm Table Showing Possible Alarm Assignments</th> </tr> <tr> <th></th> <th>R2</th> <th>R3</th> <th>R4</th> </tr> </thead> <tbody> <tr> <th>R1</th> <td>R2.t 1</td> <td>R3.t 1</td> <td>R4.t 1</td> </tr> <tr> <th>R2</th> <td></td> <td>R3.t 2</td> <td>R4.t 2</td> </tr> <tr> <th>R3</th> <td></td> <td></td> <td>R4.t 3</td> </tr> </tbody> </table>	Trailing Alarm Table Showing Possible Alarm Assignments					R2	R3	R4	R1	R2.t 1	R3.t 1	R4.t 1	R2		R3.t 2	R4.t 2	R3			R4.t 3
Trailing Alarm Table Showing Possible Alarm Assignments																						
	R2	R3	R4																			
R1	R2.t 1	R3.t 1	R4.t 1																			
R2		R3.t 2	R4.t 2																			
R3			R4.t 3																			
Rx Latch	on or OFF	<p>Relay latching on or off. When set to OFF the relay will reset automatically when the display shows the input is not in alarm condition. If a 5 digit display with alarm annunciators is used the annunciator will light solidly when the input is in alarm condition and will be extinguished when the relay resets.</p> <p>If set to on the relay will latch when it is activated by an alarm condition and can only be manually reset or acknowledged via the P button or remote input (see P.but and F.1 RP functions). If the alarm condition is acknowledged whilst still in alarm condition the relay will automatically deactivate when it moves out of alarm condition. If a 5 digit display with alarm annunciators is used the annunciators will operate in the following manner:</p> <ol style="list-style-type: none"> 1. Input goes to alarm condition - annunciator flashes on 80%, off 20%, relay is activated. 2. Input goes out of alarm condition but has not been reset - annunciator flashes on 20% , off 80%, relay activated. 3. Input in alarm condition when manually acknowledged - annunciator lit solidly, relay is activated. 4. Input out of alarm condition and reset or acknowledged - annunciator light extinguished, relay is de-activated. <p>See also the R1 OPEF, R2 OPEF etc. functions.</p>																				
br 9t	1 to 15	<p>Display brightness - displays and sets the digital display brightness. The display brightness is selectable from 1 to 15. where 1 = lowest intensity and 15 = highest intensity. This function is useful for improving the display readability in dark areas or to reduce the power consumption of the instrument.</p>																				

Function	Range	Description
dull	0 to 15	Remote display brightness - Displays and sets the level for remote input brightness switching, see F: NP function. When the remote input is set to dull the remote input can be used to switch between the display brightness level set by the brgt function and the display brightness set by the dull function. The display brightness is selectable from 0 to 15, where 0 = lowest intensity and 15 = highest intensity. This function is useful in reducing glare when the display needs to be viewed in both light and dark ambient light levels.
The functions which follow are accessible via CAL mode only or if ACCESS function is set to ALL		
bar_{low}	Value	<p>Bar graph display low value - seen only in bargraph display instruments. Displays and sets the graph low value i.e. The value on the 7 segment display at which the bargraph will start to rise. This may be independently set anywhere within the display range of the instrument.</p> <p>Note: The bar_{high} and bar_{low} settings are referenced from the 7 segment display readings, not the bargraph scale values. The bargraph scale may be scaled differently to the 7 segment display, as shown on the right where bargraph scale is 0 to 100 yet the display is showing 675.3. In this example the bargraph scale may be indicating percentage fill of a tank whilst the 7 segment display is indicating actual process units.</p> <p>The bargraph is available as a 20 segment straight bar or 16 segment circular bargraph See the bar_{type} function which follows for bargraph operation modes.</p>
bar_{high}	Value	Bargraph display high value - seen only in bargraph display instruments. Displays and sets the bar graph high value i.e. the value on the 7 segment display at which the bargraph will reach its maximum indication (all LED's illuminated). May be independently set anywhere within the display range of the instrument.



Function	Range	Description
bAr tYPE	bAr S.dot d.dot or C.bAr	<p>Bar graph display operation mode - seen only in bargraph display instruments.</p> <p>Allows selection of bargraph operation mode choices are:</p> <p>bAr - conventional solid bargraph display i.e. all LED's illuminated when at full scale. e.g. when scaling the display use the bAr and bAr functions e.g. bAr = 0 and bAr = 100 will give a bargraph with no segments lit at a 7 segment display reading of 0 and all segments lit with a 7 segment display reading of 100.</p> <p>S.dot - single dot display. A single segment will be lit to indicate the input readings position on the scale. e.g. when scaling the display use the bAr and bAr functions e.g. bAr = 0 and bAr = 100 will give a bargraph with the bottom segment lit at a 7 segment display reading of 0 and the top segment lit with a 7 segment display reading of 100.</p> <p>Note: this could also be set up as a centre zero single dot display by entering a negative value and positive value. e.g. bAr = - 100 . bAr = 100.</p> <p>d.dot - double dot display. Two segments will be lit to indicate the input reading position on the scale. The reading should be taken from the middle of the two segments. e.g. when scaling the display use the bAr and bAr functions e.g. bAr = 0 and bAr = 100 will give a bargraph with the bottom two segments lit at a 7 segment display reading of 0 and the top two segments lit with a 7 segment display reading of 100.</p> <p>Note: this could also be set up as a centre zero single dot display by entering a negative value and positive value. e.g. bAr = - 100 . bAr = 100.</p> <p>C.bAr - centre bar display. The display will be a solid bargraph but will have its zero point in the middle of the display. If the seven segment display value is positive the bargraph will rise. If the seven segment display value is negative then the bargraph will fall. e.g. when scaling the display use the bAr and bAr functions e.g. bAr = 0 and bAr = 100 will give a bargraph with all the bottom half segments lit at a 7 segment display reading of - 100 and all the top segments lit with a 7 segment display reading of 100.</p>
d9.OP	b, n2. b, n. b.SCL or bcd	<p>Digital output mode - seen only with digital output option. Refer to the separate "PM4 Panel Meter Optional Output Addendum" booklet supplied when this option is fitted.</p> <p>Selections available are: b, n2 (signed binary), b, n (unsigned binary), b.SCL (scaled binary), bcd (binary coded decimal).</p>
d9.OP	A: o or AH,	<p>Digital output polarity - seen only with digital output option. Refer to the separate "PM4 Panel Meter Optional Output Addendum" booklet supplied when this option is fitted.</p> <p>Select either A: o - active low output or AH, - active high output.</p>
bcd Start	0 to number of display digits minus 4	<p>BCD - start display position - seen only with digital output option. Refer to the separate "PM4 Panel Meter Optional Output Addendum" booklet supplied when this option is fitted.</p> <p>This function affects BCD mode only and determines the number of digits to skip when outputting from the display. Select from 0 to number of display digits minus 4. e.g. for a 6 digit display you may select 0 to 2, if 2 is selected then the four left most digits will be output.</p>
d, 9.	Value	<p>Scaled digital output low reading - seen only with digital output option. Refer to the separate "PM4 Panel Meter Optional Output Addendum" booklet supplied when this option is fitted.</p> <p>Accepts any valid display value. Determines the low scaling point for the b.SCL mode and has no effect on other modes. See example which follows.</p>

Function	Range	Description
d, 9⁻	Value	Scaled digital output high reading - seen only with digital output option. Refer to the separate "PM4 Panel Meter Optional Output Addendum" booklet supplied when this option is fitted. Accepts any valid display value. Determines the high scaling point for the b, 5CL mode and has no effect on other modes. For example if d, 9⁻ is set to 0 and d, 9⁻ is set to 65535 (2^{16}) then the retransmission will not be scaled i.e. a display of 2 will cause a retransmission of 2. If d, 9⁻ is now changed to 32767 (2^{15}) then a display of 2 will cause a retransmission of 4.
rEE₋	Value	Recorder/retransmission output low value - seen only when analog retransmission option fitted. Refer to the separate "PM4 Panel Meter Optional Output Addendum" booklet supplied when this option is fitted. Displays and sets the analog retransmission (4-20mA, 0-1V or 0-10V, link selectable) output low value (4mA or 0V) in displayed engineering units. e.g. if it is required to retransmit 4mA when the display indicates 0 then select 0 in this function via the  or  button. See also rEE function (analog output mode).
rEE⁻	Value	Recorder/retransmission output high value - seen only when analog retransmission option fitted. Refer to the separate "PM4 Panel Meter Optional Output Addendum" booklet supplied when this option is fitted. Displays and sets the analog retransmission (4-20mA, 0-1V or 0-10V, link selectable) output high value (20mA, 1V or 10V) in displayed engineering units. e.g. if it is required to retransmit 20mA when the display indicates 500 then select 500 in this function via the  or  button. See also rEE function (analog output mode).
rEE₋ CH 2	Value	Second analog recorder/retransmission output low value - seen only when the dual analog retransmission option is fitted. See rEE₋ function for description of operation. See also rEE2 function (analog output 2 mode).
rEE⁻ CH 2	Value	Second analog recorder/retransmission output high value - seen only when the dual analog retransmission option is fitted. See rEE⁻ function for description of operation. See also rEE2 function (analog output 2 mode).
dCPt	0. or 0.1	Decimal point selection - displays and sets the display resolution. By pressing the  or  pushbuttons the decimal point position may be set. The display will indicate as follows: 0. (1° resolution) or 0.1 (0.1° resolution)
FLtR	0 to 8	Digital filter - displays and sets the digital filter value. Digital filtering is used for reducing susceptibility to short term interference. The digital filter range is selectable from 0 to 8, where 0 = none and 8 = most filtering. A typical value for the digital filter would be 3. Use  or  to alter if required. Note that at higher filter values the display update time will increase.
INPt TYPE	rE2L , rE2H , rE3L or rE3H	Selects input type from: rE2L - 2 wire RTD low range. This selects the -180°C to +200°C range. rE2H - 2 wire RTD high range. This selects the -180°C to 650°C range for Pt100 or -180°C to 550°C range for Pt1000 sensors. rE3L - 3 wire RTD low range. This selects the -180°C to +200°C range. rE3H - 3 wire RTD high range. This selects the -180°C to 650°C range for Pt100 or -180°C to 550°C range for Pt1000 sensors. Note: if the input type is changed each input will need to be recalibrated. The low ranges cover only part of the RTD range this is to allow improved accuracy over this range i.e. 0.1% of 380 against 0.1% of 730 or 830.
rEd TYPE	100 or 1000	Selects RTD type from: 100 - Pt100 RTD input 1000 - Pt1000 RTD input The choice made is common for all inputs i.e. if 100 is selected then a Pt100 input is required for all channels.

Function	Range	Description
INPt chnl	1 to 4 or 1 to 8	Selects the number of input channels being used. Select 1 to 4 for three wire RTDs or 1 to 8 for two wire RTDs. For the purposes of correct display, relay operation & retransmission it is important that the correct number of channels is chosen since channels without inputs will be seen by the PM4 as a high overrange and the error message " - - - - " will be displayed for that channel.
SEt di SP	SCAN, Hi 9H, Lo, AUSE, di FF di F 1 or ch 1 to ch 8	<p>Selects the display operation mode from the choices below. In each case below the  or  button can be used to toggle between channels. If the di SP uni, t function is set to NONE, oC or oF then the channel number will be displayed prior to the reading for that channel.</p> <p>SCAN - the display will automatically scroll through each channel. The time each channel display is held is set by the SCAN dLAY function.</p> <p>Hi 9H - the highest temperature will be displayed. When scrolling through the displays using the  or  button the message Hi 9H will be displayed prior to the reading and if chr or chL is selected at the di SP uni, t function the channel number with the highest reading will then be displayed alongside the high value.</p> <p>Lo -the lowest temperature will be displayed. When scrolling through the displays using the  or  button the message Lo will be displayed prior to the reading and if chr or chL is selected at the di SP uni, t function the channel number with the lowest reading will then be displayed alongside the low value.</p> <p>AUSE - the average of all temperatures will be displayed. When scrolling through the displays using the  or  button the message AUSE will be displayed prior to the reading and if chr or chL is selected at the di SP uni, t function the letter A will then be displayed alongside the average value.</p> <p>di FF - the difference between the highest and lowest temperatures will be displayed. When scrolling through the displays using the  or  button the message di FF will be displayed prior to the reading and if chr or chL is selected at the di SP uni, t function the letter d will be displayed alongside the difference reading.</p> <p>di F 1 - the largest difference between channel 1 and the other channels used will be displayed. If channel 1 is the lowest value the difference displayed will be shown as a positive value. If channel 1 is the highest value then the difference displayed will be a negative value. When scrolling through the displays using the  or  button the message di F 1 will be displayed prior to the reading and if chr or chL is selected at the di SP uni, t function the letter d will be displayed alongside the difference reading.</p> <p>ch 1, ch 2 etc. - the channel selected will be displayed as the default display.</p>
deg type	oC, oF or ABS	<p>Sets the degree measurement type, choose from:</p> <p>oC - displays in Centigrade</p> <p>oF - displays in Fahrenheit</p> <p>ABS - displays in Absolute (Kelvin)</p>
di SP uni, t	NONE oC oF chr or chL	<p>Display unit - certain display unit characters can be selected if required, to display temperature units or to indicate which channel is being displayed. Choices are:</p> <p>NONE i.e. no display units e.g. 2345</p> <p>oC e.g. 45oC</p> <p>oF e.g. 18oF</p> <p>C e.g. 45.3C</p> <p>chr e.g. 2376 4 where 4 is the channel shown right of temperature</p> <p>chL e.g. 4 2376 where 4 is the channel shown left of temperature</p> <p>Note that when a display unit is chosen it will take up one or two of the available display digits, this may limit the maximum or minimum value which can be displayed. If the number becomes too large to display then an error message -or- will appear on the display.</p> <p>The temperature display will be on the left of the display when chnl is selected and on the right for the other choices.</p>

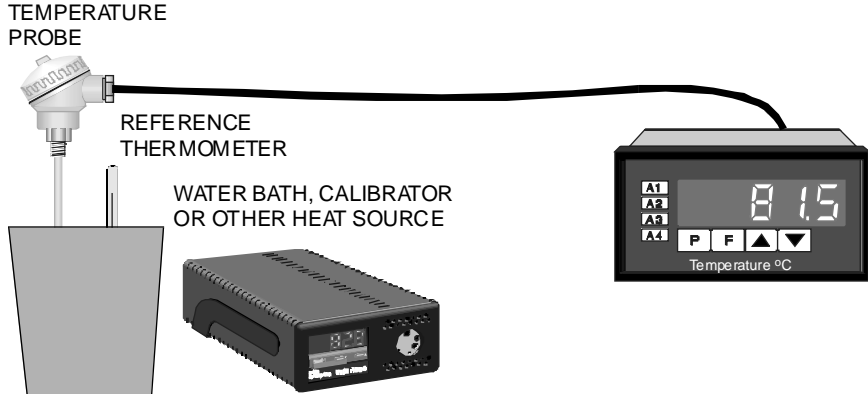
Function	Range	Description
SCAN dLAY	0 to 250	Sets the time for which each channel display is held when SEt d: SP is set to SCAN . If set to 0 the scanning operation will be disabled i.e. the display will not automatically scan and must be manually scanned using the ▲ or ▼ button.
ch 1 CAL . ch2 CAL etc.	n/a	<p>Temperature calibration for each input channel. The procedure for calibrating each channel is:</p> <ol style="list-style-type: none"> Ensure that an RTD input at a temperature of a known value is present at the input terminal of the channel being calibrated. At the calibration function for the channel being calibrated e.g. ch 1 CAL. Press ▲ and ▼ simultaneously then release them. The display will indicate the live input value. Do not be concerned at this stage if the live input display value is not what is required. It is important that the live input value seen is a steady value. If the display value does not become stable within 20 seconds then the input needs to be investigated before proceeding with the scaling. Press then release the F button. The display will indicate Ch 1 SCL (or ch2 SCL etc.) followed by a value. Use the ▲ or ▼ button to change this to the known temperature value. Press the F button to accept changes or the P button to abort the scaling. If the scaling has been accepted there will be a display message to indicate this when the F button has been pressed e.g. Ch 1 CAL End. 
UCAL Ch 1. UCAL Ch 2 etc.	n/a	Uncalibration of selected channel - used to set the selected channel back to the factory calibration values. This function should only be used when calibration problems exist and it is necessary to clear the calibration memory. To clear the memory press the ▲ and ▼ buttons simultaneously at the functions. The message CAL CLR will be seen to indicate that the memory has cleared.
P.but	NONE , H_i , L_o , H_i L_o or R.c! r	<p>P button function - applicable only in models with front panel P buttons. The P button may be set to operate some of the remote input functions, see F.i NP below for a description of these functions with the exception of FUNC which is described below. The P button is located at the front of 5 or 6 digit LED models. If both the remote input and P button function are operated simultaneously the P button will override the remote input. The functions below are as described in the F.i NP function below.</p> <p>Functions available are: NONE (no operation), H_i (peak memory), L_o (valley memory), H_i L_o (peak/valley memory toggle) or R.c! r (latching memory reset or acknowledge).</p> <p>Note: To prevent accidental operation of the P button in the R.c! r function it is necessary to hold the button in for 2 seconds to perform the selected operation.</p>

Function	Range	Description												
Γ: NP	NONE , P.HLd d.HLd H , Lo , H.Lo , SP.Ac , No.Ac , CAL.S , dULL or Ac.r	<p>Remote input function - terminals 7 and 8 at the rear of the instrument are the remote input terminals. When these pins are short circuited, via a pushbutton or keyswitch the instrument will perform the selected remote input function. A message will flash to indicate which function has been selected when the remote input pins are short circuited. Some remote input and P button operations are also controlled by the SPFNChnl function, the table below each function below shows the effect of each setting on the operation. The remote input functions are as follows:</p> <p>NONE - no remote function required.</p> <p>P.HLd - peak hold. The display will show the peak value only whilst the remote input pins are short circuited.</p> <table border="1" data-bbox="438 566 1445 1787"> <thead> <tr> <th>SPFN Chnl</th> <th>Γ: NP set to P.HLd</th> </tr> </thead> <tbody> <tr> <td>SCAN</td> <td>Scans all channels e.g. when set to SCAN if Γ: NP is set to P.HLd (peak hold) then when the remote input is activated the inputs will be scanned and the peak hold will operate on the channel with the highest reading. If the channel number is being displayed (see d: SP un t function) then the channel number for the input with the highest peak reading will be seen on the display.</td> </tr> <tr> <td>Hi GH</td> <td>Operates in the same manner as SCAN above but does not show the channel number, instead shows the letter H if the d: SP un t function is set to show a channel number.</td> </tr> <tr> <td>Lo</td> <td>Operates on the lowest of the inputs at the time e.g. when set to Lo if Γ: NP is set to P.HLd (peak hold) then when the remote input is activated the inputs will be scanned and the lowest of all the inputs will be displayed. From then on the display will only change if this low channel value increases i.e. goes more positive i.e. the operation is allowing a peak hold of the channel with the lowest value at the time the remote input was activated. The letter L will be displayed if the d: SP un t function is set to show a channel number.</td> </tr> <tr> <td>AUSE</td> <td>Operates on the average of the inputs at the time when set to AUSE if Γ: NP is set to P.HLd (peak hold) then when the remote input is activated the inputs will be scanned and the average displayed, from then on the display will show the peak average reading until the remote input is released. The letter A will be displayed if the d: SP un t function is set to show a channel number.</td> </tr> <tr> <td>d: FF</td> <td>Operates on the difference between the channels e.g. when set to d: FF if Γ: NP is set to P.HLd (peak hold) then when the remote input is activated the inputs will be scanned and the largest difference between any two channels will be displayed, from then on the display will show the maximum difference between any two channels until the remote input is released. The letter d will be displayed if the d: SP un t function is set to show a channel number.</td> </tr> </tbody> </table>	SPFN Chnl	Γ: NP set to P.HLd	SCAN	Scans all channels e.g. when set to SCAN if Γ: NP is set to P.HLd (peak hold) then when the remote input is activated the inputs will be scanned and the peak hold will operate on the channel with the highest reading. If the channel number is being displayed (see d: SP un t function) then the channel number for the input with the highest peak reading will be seen on the display.	Hi GH	Operates in the same manner as SCAN above but does not show the channel number, instead shows the letter H if the d: SP un t function is set to show a channel number.	Lo	Operates on the lowest of the inputs at the time e.g. when set to Lo if Γ: NP is set to P.HLd (peak hold) then when the remote input is activated the inputs will be scanned and the lowest of all the inputs will be displayed. From then on the display will only change if this low channel value increases i.e. goes more positive i.e. the operation is allowing a peak hold of the channel with the lowest value at the time the remote input was activated. The letter L will be displayed if the d: SP un t function is set to show a channel number.	AUSE	Operates on the average of the inputs at the time when set to AUSE if Γ: NP is set to P.HLd (peak hold) then when the remote input is activated the inputs will be scanned and the average displayed, from then on the display will show the peak average reading until the remote input is released. The letter A will be displayed if the d: SP un t function is set to show a channel number.	d: FF	Operates on the difference between the channels e.g. when set to d: FF if Γ: NP is set to P.HLd (peak hold) then when the remote input is activated the inputs will be scanned and the largest difference between any two channels will be displayed, from then on the display will show the maximum difference between any two channels until the remote input is released. The letter d will be displayed if the d: SP un t function is set to show a channel number.
SPFN Chnl	Γ: NP set to P.HLd													
SCAN	Scans all channels e.g. when set to SCAN if Γ: NP is set to P.HLd (peak hold) then when the remote input is activated the inputs will be scanned and the peak hold will operate on the channel with the highest reading. If the channel number is being displayed (see d: SP un t function) then the channel number for the input with the highest peak reading will be seen on the display.													
Hi GH	Operates in the same manner as SCAN above but does not show the channel number, instead shows the letter H if the d: SP un t function is set to show a channel number.													
Lo	Operates on the lowest of the inputs at the time e.g. when set to Lo if Γ: NP is set to P.HLd (peak hold) then when the remote input is activated the inputs will be scanned and the lowest of all the inputs will be displayed. From then on the display will only change if this low channel value increases i.e. goes more positive i.e. the operation is allowing a peak hold of the channel with the lowest value at the time the remote input was activated. The letter L will be displayed if the d: SP un t function is set to show a channel number.													
AUSE	Operates on the average of the inputs at the time when set to AUSE if Γ: NP is set to P.HLd (peak hold) then when the remote input is activated the inputs will be scanned and the average displayed, from then on the display will show the peak average reading until the remote input is released. The letter A will be displayed if the d: SP un t function is set to show a channel number.													
d: FF	Operates on the difference between the channels e.g. when set to d: FF if Γ: NP is set to P.HLd (peak hold) then when the remote input is activated the inputs will be scanned and the largest difference between any two channels will be displayed, from then on the display will show the maximum difference between any two channels until the remote input is released. The letter d will be displayed if the d: SP un t function is set to show a channel number.													

Function	Range	Description																
<i>F.I NP</i> continued	<i>NONE</i> , <i>P.HLD</i> <i>d.HLD</i> <i>H.</i> , <i>Lo</i> , <i>H.Lo</i> , <i>SP.Ac.</i> <i>No.Ac.</i> <i>CAL.S</i> , <i>dULL</i> or <i>R.cir</i>	<i>P.HLD</i> - peak hold continued.																
		<table border="1"> <thead> <tr> <th><i>SPFN</i> <i>Chnl</i></th> <th><i>F.I NP</i> set to <i>P.HLD</i></th> </tr> </thead> <tbody> <tr> <td><i>d: F 1</i></td> <td>Operates on the difference between channel 1 the remaining channels e.g. when set to <i>d: F 1</i> if <i>F.I NP</i> is set to <i>P.HLD</i> (peak hold) then when the remote input is activated the inputs will be scanned and the largest difference between channel 1 and the remaining channels will be displayed, from then on the display will show the maximum difference until the remote input is released. The letter <i>d</i> will be displayed if the <i>d: SPunit</i> function is set to show a channel number. Note that in this mode the value displayed will be negative if channel 1 is the lowest value.</td> </tr> <tr> <td><i>ch 1</i></td> <td>Operates on channel 1 only e.g. when set to <i>ch 1</i> if <i>F.I NP</i> is set to <i>P.HLD</i> (peak hold) then when the remote input is activated the display will show the peak value for channel 1. The channel number will be displayed if the <i>d: SPunit</i> function is set to show a channel number.</td> </tr> <tr> <td><i>ch2 to</i> <i>ch 8</i></td> <td>Operates on the selected channel, see <i>ch 1</i> above.</td> </tr> </tbody> </table>	<i>SPFN</i> <i>Chnl</i>	<i>F.I NP</i> set to <i>P.HLD</i>	<i>d: F 1</i>	Operates on the difference between channel 1 the remaining channels e.g. when set to <i>d: F 1</i> if <i>F.I NP</i> is set to <i>P.HLD</i> (peak hold) then when the remote input is activated the inputs will be scanned and the largest difference between channel 1 and the remaining channels will be displayed, from then on the display will show the maximum difference until the remote input is released. The letter <i>d</i> will be displayed if the <i>d: SPunit</i> function is set to show a channel number. Note that in this mode the value displayed will be negative if channel 1 is the lowest value.	<i>ch 1</i>	Operates on channel 1 only e.g. when set to <i>ch 1</i> if <i>F.I NP</i> is set to <i>P.HLD</i> (peak hold) then when the remote input is activated the display will show the peak value for channel 1. The channel number will be displayed if the <i>d: SPunit</i> function is set to show a channel number.	<i>ch2 to</i> <i>ch 8</i>	Operates on the selected channel, see <i>ch 1</i> above.								
		<i>SPFN</i> <i>Chnl</i>	<i>F.I NP</i> set to <i>P.HLD</i>															
		<i>d: F 1</i>	Operates on the difference between channel 1 the remaining channels e.g. when set to <i>d: F 1</i> if <i>F.I NP</i> is set to <i>P.HLD</i> (peak hold) then when the remote input is activated the inputs will be scanned and the largest difference between channel 1 and the remaining channels will be displayed, from then on the display will show the maximum difference until the remote input is released. The letter <i>d</i> will be displayed if the <i>d: SPunit</i> function is set to show a channel number. Note that in this mode the value displayed will be negative if channel 1 is the lowest value.															
<i>ch 1</i>	Operates on channel 1 only e.g. when set to <i>ch 1</i> if <i>F.I NP</i> is set to <i>P.HLD</i> (peak hold) then when the remote input is activated the display will show the peak value for channel 1. The channel number will be displayed if the <i>d: SPunit</i> function is set to show a channel number.																	
<i>ch2 to</i> <i>ch 8</i>	Operates on the selected channel, see <i>ch 1</i> above.																	
<i>d.HLD</i> - display hold. The display value will be held whilst the remote input pins are short circuited.																		
<table border="1"> <thead> <tr> <th><i>SPFN</i> <i>Chnl</i></th> <th><i>F.I NP</i> set to <i>d.HLD</i> (See <i>P.HLD</i> for further description)</th> </tr> </thead> <tbody> <tr> <td><i>SCAN</i></td> <td>Holds whichever channel is currently displayed</td> </tr> <tr> <td><i>HI 9H</i></td> <td>Hold whichever channel is the highest</td> </tr> <tr> <td><i>Lo</i></td> <td>Holds whichever channel is the lowest</td> </tr> <tr> <td><i>AUGE</i></td> <td>Holds the average of all channels</td> </tr> <tr> <td><i>d: FF</i></td> <td>Holds the maximum difference between any channels</td> </tr> <tr> <td><i>d: F 1</i></td> <td>Holds the maximum difference from channel 1</td> </tr> <tr> <td><i>ch 1</i></td> <td>Channel 1 value held</td> </tr> <tr> <td><i>ch2 to</i> <i>ch 8</i></td> <td>Selected channel number held</td> </tr> </tbody> </table>	<i>SPFN</i> <i>Chnl</i>	<i>F.I NP</i> set to <i>d.HLD</i> (See <i>P.HLD</i> for further description)	<i>SCAN</i>	Holds whichever channel is currently displayed	<i>HI 9H</i>	Hold whichever channel is the highest	<i>Lo</i>	Holds whichever channel is the lowest	<i>AUGE</i>	Holds the average of all channels	<i>d: FF</i>	Holds the maximum difference between any channels	<i>d: F 1</i>	Holds the maximum difference from channel 1	<i>ch 1</i>	Channel 1 value held	<i>ch2 to</i> <i>ch 8</i>	Selected channel number held
<i>SPFN</i> <i>Chnl</i>	<i>F.I NP</i> set to <i>d.HLD</i> (See <i>P.HLD</i> for further description)																	
<i>SCAN</i>	Holds whichever channel is currently displayed																	
<i>HI 9H</i>	Hold whichever channel is the highest																	
<i>Lo</i>	Holds whichever channel is the lowest																	
<i>AUGE</i>	Holds the average of all channels																	
<i>d: FF</i>	Holds the maximum difference between any channels																	
<i>d: F 1</i>	Holds the maximum difference from channel 1																	
<i>ch 1</i>	Channel 1 value held																	
<i>ch2 to</i> <i>ch 8</i>	Selected channel number held																	

Function	Range	Description																		
F.I NP continued	NONE, P.HLd d.HLd H_i, Lo, H_i Lo, SP.Ac. No.Ac. CAL.S, dULL or R.cl r	H_i - peak memory. The peak value stored in memory will be displayed if the remote input pins are short circuited, if the short circuit is momentary then the display will return to normal measurement after 20 seconds. If the short circuit is held for 1 to 2 seconds or the power is removed from the instrument then the memory will be reset. Note if the operation is changed it is necessary to reset the memory e.g. if changed from H_i to Lo .																		
		<table border="1"> <tr> <td>SPFN Chnl</td> <td>F.I NP set to H_i (See P.HLd for further description)</td> </tr> <tr> <td>SCAN</td> <td>Shows whichever channel is or has been the highest</td> </tr> <tr> <td>HI GH</td> <td>Shows whichever channel is or has been the highest</td> </tr> <tr> <td>Lo</td> <td>Shows whichever channel is or has been the lowest then only changes if this channel value increases</td> </tr> <tr> <td>AUSE</td> <td>Shows the highest average of all channels</td> </tr> <tr> <td>dIFF</td> <td>Shows the maximum difference between any channels</td> </tr> <tr> <td>dIF1</td> <td>Shows the maximum difference from channel 1</td> </tr> <tr> <td>ch1</td> <td>Shows channel 1 peak value</td> </tr> <tr> <td>ch2 to ch8</td> <td>Shows selected channel number peak value</td> </tr> </table>	SPFN Chnl	F.I NP set to H_i (See P.HLd for further description)	SCAN	Shows whichever channel is or has been the highest	HI GH	Shows whichever channel is or has been the highest	Lo	Shows whichever channel is or has been the lowest then only changes if this channel value increases	AUSE	Shows the highest average of all channels	dIFF	Shows the maximum difference between any channels	dIF1	Shows the maximum difference from channel 1	ch1	Shows channel 1 peak value	ch2 to ch8	Shows selected channel number peak value
		SPFN Chnl	F.I NP set to H_i (See P.HLd for further description)																	
		SCAN	Shows whichever channel is or has been the highest																	
		HI GH	Shows whichever channel is or has been the highest																	
		Lo	Shows whichever channel is or has been the lowest then only changes if this channel value increases																	
		AUSE	Shows the highest average of all channels																	
		dIFF	Shows the maximum difference between any channels																	
		dIF1	Shows the maximum difference from channel 1																	
		ch1	Shows channel 1 peak value																	
ch2 to ch8	Shows selected channel number peak value																			
<p>Lo - valley memory. The minimum value stored in memory will be displayed. Otherwise operates in the same manner as the H_i function. Note if the operation is changed it is necessary to reset the memory e.g. if changed from H_i to Lo.</p>																				
<table border="1"> <tr> <td>SPFN Chnl</td> <td>F.I NP set to Lo (See P.HLd for further description)</td> </tr> <tr> <td>SCAN</td> <td>Shows whichever channel is or has been the lowest</td> </tr> <tr> <td>HI GH</td> <td>Shows whichever channel is or has been the lowest</td> </tr> <tr> <td>Lo</td> <td>Shows whichever channel is or has been the lowest then only changes if this channel value decreases</td> </tr> <tr> <td>AUSE</td> <td>Shows the lowest average of all channels</td> </tr> <tr> <td>dIFF</td> <td>Shows the minimum difference between any channels</td> </tr> <tr> <td>dIF1</td> <td>Shows the minimum difference from channel 1</td> </tr> <tr> <td>ch1</td> <td>Shows channel 1 valley value</td> </tr> <tr> <td>ch2 to ch8</td> <td>Shows selected channel number valley value</td> </tr> </table>	SPFN Chnl	F.I NP set to Lo (See P.HLd for further description)	SCAN	Shows whichever channel is or has been the lowest	HI GH	Shows whichever channel is or has been the lowest	Lo	Shows whichever channel is or has been the lowest then only changes if this channel value decreases	AUSE	Shows the lowest average of all channels	dIFF	Shows the minimum difference between any channels	dIF1	Shows the minimum difference from channel 1	ch1	Shows channel 1 valley value	ch2 to ch8	Shows selected channel number valley value		
SPFN Chnl	F.I NP set to Lo (See P.HLd for further description)																			
SCAN	Shows whichever channel is or has been the lowest																			
HI GH	Shows whichever channel is or has been the lowest																			
Lo	Shows whichever channel is or has been the lowest then only changes if this channel value decreases																			
AUSE	Shows the lowest average of all channels																			
dIFF	Shows the minimum difference between any channels																			
dIF1	Shows the minimum difference from channel 1																			
ch1	Shows channel 1 valley value																			
ch2 to ch8	Shows selected channel number valley value																			
<p>H_i Lo - toggle between H_i and Lo displays. This function allows the remote input to be used to toggle between peak and valley memory displays. The first operation of the remote input will cause the peak memory value to be displayed, the next operation will give a valley memory display. PH_i or PLo will flash before each display to give an indication of display type.</p>																				
<table border="1"> <tr> <td>SPFN Chnl</td> <td>F.I NP set to H_i Lo (See P.HLd for further description)</td> </tr> <tr> <td colspan="2">Operates as above H_i and Lo but will toggle between high and low readings each time remote input is activated.</td> </tr> </table>	SPFN Chnl	F.I NP set to H_i Lo (See P.HLd for further description)	Operates as above H_i and Lo but will toggle between high and low readings each time remote input is activated.																	
SPFN Chnl	F.I NP set to H_i Lo (See P.HLd for further description)																			
Operates as above H_i and Lo but will toggle between high and low readings each time remote input is activated.																				

Function	Range	Description
F.I NP continued	NONE , P.HLd d.HLd H , Lo , H.Lo , SP.Ac . No.Ac . CAL.S , dULL or R.cl r	SP.Ac - setpoint access only. This blocks access to any functions except the alarm setpoint functions unless the remote input pins are short circuited or entry is made via CAL mode. No.Ac - no access. This blocks access to all functions unless the remote input pins are short circuited or entry is made via CAL mode. dULL - display brightness control. The remote input can be used to change the display brightness. When this mode is selected the display brightness can be switched, via the remote input, between the brightness level set at the brgt function and the brightness level set at the dULL function. R.cl r - acknowledge or reset alarm, used when Rx Latch is set to on i.e. when using latching alarm relays. The remote input can be used to acknowledge an alarm condition or reset the alarm. If the remote input is activated when there is still an alarm condition then the alarm will be acknowledged and the relay will automatically reset when the input moves out of alarm condition. If the remote input is activated when the input has been in an alarm condition but is no longer in alarm condition then the relay will immediately reset. See Rx Latch function for further description of latching operation.
SPFN chn1	SCAN . H: 9H . Lo . AUGE . d: FF . d: F1 . ch1 . ch2 to ch8	Remote or P button function mode of operation. This function sets the operation mode for the remote input (F.I NP function) or P button (P.but function) operation. See F.I NP function for a description of the operation of the SPFNchn1 functions.
ACCS	OFF , EASY . NONE or ALL	Access mode - the access mode function ACCS has four possible settings namely OFF , EASY . NONE and ALL . If set to OFF the mode function has no effect on alarm relay operation. If set to EASY the easy alarm access mode will be activated, see details at the beginning of this chapter preceding the A ILo function. If set to NONE there will be no access to any functions via FUNC mode, entry via CAL mode must be made to gain access to alarm and calibration functions. If set to ALL then access to all functions, including calibration functions, can be gained via FUNC mode.
SPAC	A 1 , A 1-2 etc	Setpoint access - seen only if more than 1 relay fitted. Sets the access to the alarm relay set points. The following choices are available: A 1 - allows setpoint access to alarm 1 only. A 1-2 - allows access to alarms 1 and 2. A 1-3 - allows access to alarms 1,2 and 3. A 1-4 - allows access to alarms 1, 2, 3 and 4 The remote input function (F.I NP) must be set to SP.Ac for this function to operate. Note: Only the setpoints which have been given a value will be accessible e.g. if A 1H is set to OFF then there will be no access to the A 1H function when SPAC is used.

Function	Range	Description
A1 OPER A2 OPER etc.	H1 9H Lo AUSE d1 FF d1 F1 ch1 ch2 ch3 ch4 ch5 ch6 ch7 or ch8	<p>Alarm relay operation mode for relays 1, 2 etc.</p> <p>The following choices are available for alarm operation mode:</p> <p>H1 9H - relay operates from the highest input. e.g. if the A IH function is set to 100 then relay 1 will activate if the highest input is 100° or higher.</p> <p>Lo - relay operates from the lowest input e.g. if the A IH function is set to 100 then relay 1 will activate only when the lowest input is 100° or higher.</p> <p>AUSE - relay operates from the average of all inputs. e.g. if the A IH function is set to 100 then relay 1 will activate only when the average of all inputs is 100° or higher.</p> <p>d1 FF - relay operates from the difference between the lowest and highest values. e.g. if the A IH function is set to 100 then relay 1 will activate only when the difference between the lowest & highest inputs is 100° or higher.</p> <p>d1 F1 - relay operates from the difference between channel 1 and the other channels operating. If channel 1 is the lowest display value channel then the difference displayed will be positive. If channel 1 is not the lowest display value channel the difference displayed will be negative. e.g. If the A IH function is set to 100 then relay 1 will operate if any active channel becomes 100° or higher than channel 1.</p> <p>ch1, ch2 etc. - relay operates from the selected channel e.g. If ch2 is chosen and the A IH function is set to 100 then relay one will activate if channel 2 input is 100° or higher.</p>
BAG	H1 9H Lo AUSE d1 FF d1 F1 ch1 ch2 ch3 ch4 ch5 ch6 ch7 or ch8	<p>Bargraph operation mode - applicable only to bargraph displays.</p> <p>The following choices are available for bargraph operation mode:</p> <p>H1 9H - bargraph indicates the highest input.</p> <p>Lo - bargraph indicates the lowest input.</p> <p>AUSE - bargraph indicates the average of all inputs.</p> <p>d1 FF - bargraph indicates the difference between the lowest and highest values.</p> <p>d1 F1 - bargraph indicates the difference between channel 1 and the other channels, note this will be a positive reading only if channel 1 is lower than the other channels.</p> <p>ch1, ch2 etc. - bargraph indicates the selected channel.</p>
FEC or d9.OP	H1 9H Lo AUSE d1 FF d1 F1 ch1 ch2 ch3 ch4 ch5 ch6 ch7 or ch8	<p>FEC analog retransmission operation mode or d9.OP (digital output retransmission). Refer to the separate "PM4 Panel Meter Optional Output Addendum" booklet supplied when optional outputs are fitted.</p> <p>The following choices are available for analog and digital retransmission operation mode:</p> <p>H1 9H - highest input is retransmitted.</p> <p>Lo - lowest input is retransmitted.</p> <p>AUSE - the average of all inputs is retransmitted.</p> <p>d1 FF - the difference between the lowest and highest values is retransmitted.</p> <p>d1 F1 - the difference between channel 1 and the other channels will be retransmitted.</p> <p>ch1, ch2 etc. - the selected channel is retransmitted.</p>

Function	Range	Description
FEC2	Hi 9H . Lo . RUGE . di FF . di F 1 . ch 1 . ch 2 . ch 3 . ch 4 . ch 5 . ch 6 . ch 7 or ch 8	Analog retransmission mode for output 2 (only seen when dual analog retransmission option is fitted). Refer to FEC function above for description.
bAud	300 . 600 . 1200 . 2400 . 4800 . 9600 . 19.2 or 38.4 .	Set baud rate - seen only with serial output option. Refer to the separate "PM4 Panel Meter Optional Output Addendum" booklet supplied when this option is fitted. Select from 300 . 600 . 1200 . 2400 . 4800 . 9600 . 19.2 or 38.4 .
Prty	NONE , EVEN or odd	Set parity - seen only with serial output option. Refer to the separate "PM4 Panel Meter Optional Output Addendum" booklet supplied when this option is fitted. Select parity check to either NONE , EVEN or odd .
O.Put	NONE , d, SP . Cont . POLL or R.bus	Set RS232/485 interface mode - seen only with serial output option. Refer to the separate "PM4 Panel Meter Optional Output Addendum" booklet supplied when this option is fitted. Select NONE , d, SP , Cont , POLL or R.bus . Allows user to select the RS232/485 interface operation as follows:- NONE No communications d, SP Sends image data from the display without conversion to ASCII. Cont Sends ASCII form of display data every time display is updated. POLL Controlled by computer or PLC as host. Host sends command via RS232/485 and instrument responds as requested. R.bus A special communications mode used with Windows compatible optional PC download software. Refer to the user manual supplied with this optional software.
Addr	0 to 31	Set unit address for polled (POLL) mode (0 to 31) - seen only with serial output option. Refer to the separate "PM4 Panel Meter Optional Output Addendum" booklet supplied when this option is fitted. Allows several units to operate on the same RS485 interface reporting on different areas etc. The host computer or PLC may poll each unit in turn supplying the appropriate address. The unit address ranges from 0 to 31 (DEC) but is offset by 32 (DEC) to avoid clashing with ASCII special function characters (such as <STX> and <CR>). Therefore 32 (DEC) or 20 (HEX) or ! (ASCII) is address 0, 42 (DEC) or 2A (HEX) or * (ASCII) addresses unit 10.

Returning to normal measure mode

When the calibration has been completed it is advisable to return the instrument to the normal mode (where calibration functions cannot be tampered with). To return to normal mode, turn off power to the instrument, wait a few seconds and then restore power.

5.2 Error messages

Display shows Ch 1 9A: N Err, Ch2 9A: N Err etc. - this message may be seen following an attempt to calibrate an input. The message indicates that the input resistance measured does not correspond to the scale value entered. Check that the input sensor and that the correct selection has been made in software for this type of sensor.

Unstable display - if the display is not stable the usual cause is either that the input signal is unstable or that the calibration scaling was incorrectly attempted. If the calibration scaling was unsuccessful then uncalibrating the display at the **UCAL** function should return the display to stable readings but the previous calibration scaling values will be lost. If the display is still not stable after uncalibrating then check the input for stability and noise.

Display shows - - - - - this message indicates that the input signal is higher than the range selected. e.g. for an input set for **FE 3L** (low range 3 wire RTD) the **- - - -** message will be seen if the input goes much higher than 220°C. Check the **TEMP TYPE** function setting corresponds to the temperature range you wish to display, if this is correct then check that the sensor resistance is within the expected range for that temperature.

Display shows -or- (or **-o°C** or **-o°F**) - this message indicates either that the number is too big to display. This can particularly easily occur if a display showing units and/or channels is being used e.g. **1255°C** can be displayed on a 6 digit display but the **-or-** message will be seen instead of this value if a 5 digit display is used. In these circumstances it may be necessary to remove the display units (**°C**) or reduce the resolution by setting no decimal point places.

Display shows NO ACCESS or NO SPAC - this message indicates that access to **FUNC** mode has been blocked by either the **F: NP** function or the **ACCESS** function. Enter **CAL** mode and check the setting of these functions and alter if required.

Display shows alarm setpoint whenever an attempt to enter FUNC mode is made - this indicates that "easy alarm access" is activated at the **ACCESS** function, enter **CAL** mode and check the setting of this function and alter if required.

Display show letter H, L, A or d rather than the channel number - this indicates that the **SPFN chn i** or **SEt d: SP** function has been set to show the highest (**H**), lowest (**L**), average (**A**), difference between all channels or difference from channel 1 (**d**). Check the **SPFN chn i** and **SEt d: SP** function and alter if required. Note: these letters or channel numbers will only be seen if the **d: SP Uni, t** function is set to **chl** or **chr**.

Display not as expected when the remote input is used - check that the **SEt d: SP** and **SPFN chn i** functions are set as required since they can be set to display different reading types. For example the **SEt d: SP** can be set to show the difference between all channels whilst the **SPFN chn i** can be used with the remote input to give a display based on the average e.g. The remote input can be set to display hold the average value. **Note:** both the difference (**d: FF**) and difference from channel 1 (**d: F i**) selections may display the letter **d** as the channel indicator, if in doubt check which mode has been selected at the **SEt d: SP** and **SPFN chn i** functions.

6 Function Table

Initial display	Meaning of display	Next display	Default Setting	Record Your Settings
<i>RxLo</i>	Alarm low setpoint value	Setpoint value or OFF	OFF	See following table
<i>RxHi</i>	Alarm high setpoint value	Setpoint value or OFF	OFF	See following table
<i>RxHY</i>	Alarm hysteresis	Hysteresis value in measured units	10	See following table
<i>Rxtt</i>	Alarm trip time	No of seconds before relay trips	0.0	See following table
<i>Rxrt</i>	Alarm reset time	Reset time in seconds	0.0	See following table
<i>Rxn.o</i> or <i>Rxn.c</i>	Alarm action N/O or N/C	<i>Rxn.o</i> or <i>Rxn.c</i>	A In.o	See following table
<i>Rx.SP</i> or <i>Rx.t!</i>	Setpoint or trailing alarm	<i>Rx.SP</i> or <i>Rx.t!</i>	Rx.SP	See following table
<i>Rx Latch</i>	Alarm latching operation	on or OFF	OFF	See following table
<i>brgt</i>	Display brightness	1 to 15	15	
<i>dull</i>	Remote display brightness switching	0 to 15	1	
<i>bAr₋</i>	Bargraph low reading	Value in memory	0	
<i>bAr₊</i>	Bargraph high reading	Value in memory	1000	
Functions below are accessible only via CAL mode or if ACCESS function is set to ALL .				
<i>bAr TYPE</i>	Bargraph operation mode	<i>bAr.S.dot.d.dot</i> or <i>C.bAr</i>	bAr	
<i>d9OP</i>	Digital output mode	<i>bcd.b.SCL</i> , <i>b₁n</i> or <i>b₁n2</i>	b₁n2	
<i>d9.OP</i>	Digital retransmission output polarity	ALo or AH₁	ALo	
<i>bcd Start</i>	BCD retransmission start value	Value in memory	0	
<i>di9₋</i>	Scaled digital output low reading	Value in memory	0	
<i>di9₊</i>	Scaled digital output high reading	Value in memory	1000	
<i>rEC₋</i>	Analog retransmission 1 output low limit	Value in memory	0	
<i>rEC₊</i>	Analog retransmission 1 output high limit	Value in memory	1000	
<i>rEC₋ Ch2</i>	Analog retransmission 2 output low limit	Value in memory	0	
<i>rEC₊ Ch2</i>	Analog retransmission 2 output high limit	Value in memory	1000	
<i>dCPt</i>	Display decimal point	0 or 0.1	0	
<i>FLtr</i>	Digital filter, range 0 to 8	0 to 8 (8 = most filtering)	3	
<i>INPt TYPE</i>	Input type	<i>rE2L</i> , <i>rE2H</i> , <i>rE3L</i> or <i>rE3H</i>	rE3L	
<i>rtdTYPE</i>	RTD type	100 or 1000	100	
<i>INPt chn!</i>	Number of inputs	1 to 4 or 1 to 8	4	
<i>SEt di SP</i>	Display type	SCAN , Hi9H , Lo , AUSE , diFF , diF1.ch1 , ch2 , ch3 , ch4 , ch5 , ch6 , ch7 or ch8	SCAN	
<i>dEGTYPE</i>	Degree type	°C , °F or AbS		
<i>di SP unit</i>	Display units	NONE , °C , °F , ch r or ch L	NONE	
<i>SCAN dLAY</i>	Scan delay seconds	0 to 250	10	
<i>ch1CAL</i> , <i>ch2CAL</i> etc.	Calibration for first, second channel etc	Live reading	n/a	

Initial display	Meaning of display	Next display	Default Setting	Record Your Settings
<i>UCAL Ch 1.</i> <i>UCAL Ch2</i> etc.	Uncalibrate channel 1, channel 2 etc	<i>CAL CLR</i>	n/a	
<i>P.but</i>	P button operation	<i>NONE.Hi. Lo.Hi.Lo</i> or <i>R.cl r</i>	<i>NONE</i>	
<i>FINP</i>	Remote input operation	<i>NONE.P.HLd.d.HLd.Hi.Lo. Hi.Lo.SP.Ac.No.Ac. CAL.S.duLL</i> or <i>R.cl r</i>		
<i>SPFN chn1</i>		<i>SCAN.Hi 9H.Lo.AUSE.di FF. di F 1.ch 1.ch2 to ch8</i>		
<i>ACCESS</i>	Access mode	<i>OFF.EASY.NONE</i> or <i>ALL</i>	<i>OFF</i>	
<i>SPAC</i>	Setpoint access	<i>R 1.R 1-2</i> etc.	<i>R 1</i>	
<i>R 1 OPEF . R2 OPEF</i> etc.	Alarm relay operation mode	<i>Hi 9H.Lo.AUSE.di FF.di F 1. ch 1.ch2.ch3.ch4.ch5. ch6.ch7</i> or <i>ch8</i>	<i>Hi 9H</i>	
<i>bARG</i>	Bargraph operation mode	<i>Hi 9H.Lo.AUSE.di FF.di F 1. ch 1.ch2.ch3.ch4.ch5. ch6.ch7</i> or <i>ch8</i>	<i>Hi 9H</i>	
<i>dg.OP</i>	Digital output mode	<i>Hi 9H.Lo.AUSE.di FF.di F 1. ch 1.ch2.ch3.ch4.ch5. ch6.ch7</i> or <i>ch8</i>	<i>Hi 9H</i>	
<i>FEC</i>	Analog retransmission mode, output 1	<i>Hi 9H.Lo.AUSE.di FF.di F 1. ch 1.ch2.ch3.ch4.ch5. ch6.ch7</i> or <i>ch8</i>	<i>Hi 9H</i>	
<i>FEC2</i>	Analog retransmission mode, output 2	<i>Hi 9H.Lo.AUSE.di FF.di F 1. ch 1.ch2.ch3.ch4.ch5. ch6.ch7</i> or <i>ch8</i>	<i>Hi 9H</i>	
<i>BAUD RATE</i>	Baud rate	<i>300, 600, 1200, 2400, 4800, 9600, 19.2</i> or <i>38.4</i>	<i>9600</i>	
<i>Prty</i>	Parity select	<i>NONE, EVEN</i> or <i>Odd</i>	<i>NONE</i>	
<i>OPUt</i>	Serial communications mode	<i>di SP.Cont.POLL</i> or <i>R.buS</i>	<i>Cont</i>	
<i>Addr</i>	Set unit address for poll mode	<i>0 to 31</i>	<i>0</i>	

Note: Functions shown shaded on this table will be displayed, only when those particular options are fitted. Refer to the separate "PM4 Panel Meter Optional Output Addendum" booklet supplied when these options are fitted.

Settings for relays - record settings here				
	A1	A2	A3	A4
<i>RxLo</i>				
<i>RxHi</i>				
<i>RxHY</i>				
<i>RxLt</i>				
<i>Rxrt</i>				
<i>Rxn.o</i> or <i>Rxn.c</i>				
<i>RxLetch</i>				
<i>Rx.SP</i> or <i>Rx.t 1</i>	n/a			
<i>Rx OPEF</i>				

7 Specifications

7.1 Technical Specifications

Input Types:	Up to 4 x 3 wire Pt100 RTD or Up to 4 x 3 wire Pt1000 RTD or Up to 8 x 2 wire Pt100 RTD or Up to 8 x 2 wire Pt1000 RTD
Display resolution:	1° or 0.1°
ADC Resolution:	1 in 20,000
Display accuracy:	0.1% of full scale when calibrated ±1 digit
Sample Rate:	1 channel sampled per second for 3 wire inputs 1 channel sampled per half second for 2 wire inputs
Conversion Method:	Dual Slope ADC
Microprocessor:	MC68HC11F CMOS
Ambient Temperature:	-10 to 60°C
Humidity:	5 to 95% non condensing
Display:	5 digit 14.2mm + status LEDs + 4 way keypad. 6 digit 14.2mm + 4 way keypad LED Bar Graph 20 segment bar + 5 digit 7.6mm + relay status LEDs
Power Supply:	AC 240V, 110V or 24V 50/60Hz or DC isolated wide range 12 to 48V. Special supply types 32VAC, 48VAC 50/60Hz or DC isolated 50 to 110V also available. Note: supply type is factory configured
Power Consumption:	AC supply 4 VA max, DC supply (depends on display type & options). Typical consumption for PM4 with no options is 100mA @ 12VDC and 50mA @ 24VDC)
Output (standard):	1 relay, Form A, Voltage free output, rated 5A @ 240VAC resistive load
Relay Action:	Programmable N.O. or N.C

7.2 Output Options

Extra Relays:	Same specs. as Relay 1 (up to 3 extra relays)
Analog Retransmission:	4 to 20mA, 0 to 1V or 0 to 10V link selectable single or dual analog output versions available (4-20mA will drive into resistive loads of up to 800Ω)
Serial Communications:	RS232 or RS485 serial comms. (type is factory configured)
Digital Retransmission	BCD/Binary (isolated)
DC Voltage Output:	Isolated ±12V(24V) standard, ±5V(10V) link selectable (rated at 20mA)

7.3 Physical Characteristics

Bezel Size:	DIN 48mm x 96mm x 10mm
Case Size:	44mm x 91mm x 120mm behind face of panel
Panel Cut Out:	45mm x 92mm +1mm &- 0mm
Connections:	Plug in screw terminals (max 2.5mm wire)
Weight:	400 gms Basic model, 450 gms with option card

Guarantee and Service

The product supplied with this manual is guaranteed against faulty workmanship for a period of 2 years from the date of dispatch.

Our obligation assumed under this guarantee is limited to the replacement of parts which, by our examination, are proved to be defective and have not been misused, carelessly handled, defaced or damaged due to incorrect installation. This guarantee is VOID where the unit has been opened, tampered with or if repairs have been made or attempted by anyone except an authorised representative of the manufacturing company.

Products for attention under guarantee (unless otherwise agreed) **must be returned to the manufacturer freight paid** and, if accepted for free repair, will be returned to the customers address in Australia free of charge.

When returning the product for service or repair a full description of the fault and the mode of operation used when the product failed must be given.

In any event the manufacturer has no other obligation or liability beyond replacement or repair of this product.

Modifications may be made to any existing or future models of the unit as it may deem necessary without incurring any obligation to incorporate such modifications in units previously sold or to which this guarantee may relate.

**This document is the property of
the instrument manufacturer
and may not be reproduced in whole or part without the
written consent of the manufacturer.**

This product is designed and manufactured in Australia.